



# High Performance Hydrogen<sup>®</sup> Bell-type Annealing Plants

Recrystallizing and Bright Annealing of Steel Strip  
in a Hydrogen Atmosphere



# TENOVA LOI THERMPROCESS

Tenova LOI Thermprocess is one of the leading companies in supplying industrial furnace systems for the heat treatment of metals. Worldwide clients from the steel, aluminium and automotive industries rely on the technical solution competence and thousands of references backed by a history of over 100 years representing the entire know-how in the field of material properties and secondary metallurgy. Tenova LOI Thermprocess is a global partner represented in all major markets throughout the world.

Being a driver in the transformation of the metals industry towards decarbonization and sustainability, we implement proven thermoprocessing solutions and focus on the development and implementation of fossil-free annealing technologies, especially Hydrogen, as well as electrical heating capabilities in new plants and revamps. The wide portfolio of technologies for reheating and heat treatment plants meets the most demanding market requirements.

As digitalization is one of the key drivers in our business, all our processes are enhanced by our smart digital solutions. We provide the full range of solutions for the whole life-cycle of the equipment from a single source: from new plants to modernization, maintenance and service.

Tenova LOI Thermprocess offers reliable and green solutions that minimize the environmental impact and guarantee quality, production efficiency and safety. Tenova LOI Thermprocess is a trademark of Tenova.

# The Leading Bell-type Annealing Equipment Producer with many Years of Plant and Process Experience

Tenova LOI Thermprocess, including the activities of its predecessors Matthias Ludwig and Nassheuer, has been a technological market leader in Bell-type Annealing Furnaces for more than 70 years. Throughout the world, more than 8,500 LOI annealing bases have been installed. About 5,000 operate with an HNx controlled

atmosphere. More than 3,500 bases use HPH® annealing technology with pure hydrogen. Tenova LOI Thermprocess is therefore also a market leader in the field of high performance hydrogen annealing plants for steel strip. Tenova LOI Thermprocess has installed more than 300 Bell-type Annealing Plants

in more than 30 countries and these plants produce about 45 million tonnes of wide, medium-width and narrow strip each year. In addition, more than 350 HNx bases have now been modernized for use with advanced HPH® technology.



## Economics and product quality are the factors that count

This is why Tenova LOI already ensures during the planning stage that the plant configuration is ideally adapted to the needs and wishes of the customer. The know-how developed by the company over the decades is also made available to sales engineers in the form of computer-aided plant layout and presentation programs.

## Training, research and development included

Tenova LOI Thermprocess has comprehensive expertise in HPH® Bell-type Annealing technology and is continuously developing this expertise by practical tests. The process expertise needed by customers for the successful operation of Tenova LOI plants is provided in the form of training and plant familiarization programs.

# The Full Range of Heat Treatment Plants for Steel Strip

Tenova LOI Thermprocess is a company of the Tenova Group and the world market leader in industrial furnaces for metals. Tenova LOI Thermprocess builds plants for the heating and heat treatment of advanced materials and can offer a full range of industrial furnace

plants for almost all applications in the metals industry.

As part of the Tenova Group, with units such as Tenova Strip Processing, Tenova LOI Thermprocess benefits from additional synergy effects for the iron, steel and aluminium industries.

The Tenova Group consists of a network of individual companies active in all the key markets throughout the world. Thanks to strong synergy effects, the entire group is an effective problem solver in all areas of thermal processing technology.



## ANNEALING AND PICKLING LINES

Stainless steel

Max. capacity	225 t/h
Strip width	600 - 2,100 mm
Strip thickness	0.3 - 7 mm
Application range	Hot and cold-rolled steel; AISI 300 and 400
Process temperature	Up to 1,200 °C
Heating system	Gas-fired
Process atmosphere	Flue gas



## ANNEALING AND PICKLING LINES

Electrical steel (GO/NGO)

Max. capacity	90 t/h
Strip width	750 - 1,350 mm
Strip thickness	1.0 - 3.5 mm
Application range	Hot and cold rolled silicon steel (GO/NGO)
Process temperature	Up to 1,170 °C
Heating system	Gas-fired, electric
Process atmosphere	Flue gas / N <sub>2</sub>



## HPH® BELL-TYPE ANNEALING PLANTS

Carbon steel, stainless steel

Max. capacity	3.1 t/h per base
Strip width	10 - 2,200 mm
Strip thickness	0.1 - 10 mm
Application range	Cold-rolled steel; CQ to EDDQ, HSLA, tinfoil T1 to T5, AISI 400
Process temperature	350 to 900 °C
Heating system	Gas, oil-fired or electric
Process atmosphere	Up to 100 % H <sub>2</sub>

### CONTINUOUS GALVANIZING LINES (HORIZONTAL)

Carbon steel

Max. capacity	150 t/h at 180 m/min
Strip width	600 - 2,060 mm
Strip thickness	0.15 - 4.5 mm
Application range	Hot and cold-rolled steel; CQ to EDDQ
Process temperature	730 to 830 °C
Heating system	Gas-fired
Process atmosphere	Protective Atmosphere (H <sub>2</sub> + N <sub>2</sub> )



### DECARBURIZING AND COATING LINES

Grain-oriented electrical strip

Max. capacity	20 t/h at 120 m/min
Strip width	720 - 1,250 mm
Strip thickness	0.15 - 0.35 mm
Application range	Grain-oriented electrical strip
Process temperature	750 to 1,050 °C
Heating system	Gas-fired, electric, induction
Process atmosphere	Protective atmosphere (H <sub>2</sub> + N <sub>2</sub> )



### FLATTENING AND COATING LINES

Grain-oriented electrical strip

Max. capacity	23 t/h at 140 m/min
Strip width	730 - 1,250 mm
Strip thickness	0.15 - 0.35 mm
Application range	Grain-oriented electrical strip
Process temperature	800 to 850 °C
Heating system	Gas-fired, electric
Process atmosphere	Protective atmosphere (H <sub>2</sub> + N <sub>2</sub> )



### ANNEALING AND COATING LINES

Non-grain-oriented electrical strip

Max. capacity	50 t/h at 180 m/min
Strip width	700 - 1,650 mm
Strip thickness	0.10 - 1.0 mm
Application range	Non-grain-oriented electrical strip
Process temperature	Up to 1,150 °C
Heating system	Gas-fired, electric, induction
Process atmosphere	Protective atmosphere (H <sub>2</sub> + N <sub>2</sub> )



# THE MAIN APPLICATIONS OF HPH<sup>®</sup> TECHNOLOGY

The decision in favour of a continuous or Bell-type Annealing Plant can only be taken on the basis of the specific details of a project. In many cases, an HPH<sup>®</sup> Bell-type Annealing Plant has the following advantages over continuous annealing technology:

- Higher quality in the case of non-alloyed extra deep drawing grades
- Higher flexibility with regard to product range and capacity utilization
- Lower capital cost
- Lower operating expenses
- Lower maintenance expenses
- Possibility of modular expansion in several stages





▲ HPH® Bell-type Annealing Plant with Jet cooling for annealing medium-width strip

### FROM HOT BAND TO EXTRA LIGHT GAUGE

- Non-alloyed
- Micro-alloyed and
- High-alloy steel coils

### FROM WIDE TO NARROW STRIP

- Narrow, medium-width and wide strip coils
- Max. coil outside diameter 2,700 mm
- Max. coil stack height 6,600 mm
- Max. stack mass 220 t

### MATERIAL GRADES

- Vacuum-decarburized, low-carbon to high-carbon steels
- Light-gauge sheet, CQ to EDDQ (surface quality for external components)
- Tinplate T1 to T5
- Cr steels (ferritic and martensitic)
- IF and ULC steels
- Micro-alloyed (HSLA) steels
- Bake hardenable (BH) steels
- Strip for galvanizing

### APPLICATIONS

Steel strip annealed in HPH® plants is used for a variety of products, including:

- Vehicle bodies
- Automobile components
- Packaging and cans
- Radiators and other heating appliances
- Household goods
- White products
- Electrical appliances
- Housings
- Fittings
- Strip for cold plating
- Silicon Steel GO (MBAF)
- Silicon Steel NGO

◀ A special application of HPH® technology: extra deep drawing grades of the type needed for aerodynamically shaped car bodies

# THE SPECIAL FEATURES OF LOI HPH<sup>®</sup> BELL-TYPE ANNEALING PLANTS AT A GLANCE

Tenova LOI's comprehensive HPH<sup>®</sup> Annealing Plant expertise is the result of decades of technical optimization. More than 70 years of experience with Bell-type Annealing Plants are reflected not only in a wide variety of innovative details but also in comprehensive process engineering expertise that LOI customers can build on.







▲ Unsurpassed control concept

▲ HPH® Bell-type Annealing Plant for cold-rolled steel strip, equipped with 99 bases

**TRIED AND TESTED  
BASE DESIGN**

- Virtually unlimited service life
- Very low dew point for the highest possible process quality and strip cleanliness

**VARIOUS COOLING  
ALTERNATIVES FOR  
SPECIFIC APPLICATIONS**

- Water spray cooling, Jet cooling, Bypass + Jet cooling

- Precisely controlled cooling process
- Final cooling to skin pass temperature, also with air drying to prevent corrosion

**UNSURPASSED CONTROL  
CONCEPT**

- Scalable control concept focusing on safe, reliable plant operation
- Implementation of existing Bell-type Annealing Plants into the automation system is possible

- The automation concept fulfills the special requirements of the automotive industry
- Optimization programs for Bell-type Annealing Plant operation:
  - Stack optimization (StackSet)
  - Annealing and cooling calculation (HeatMod)
  - Equipment scheduling (ShopRun)
  - Sticker prevention (StickerMod)
  - Material and equipment tracking (FlowTrac)

**THE TENOVA LOI RECIRCULATION FAN**

- High-performance impeller designed and optimized by FEM calculations, for hydrogen flow rates up to 130,000 m<sup>3</sup>/h
- Frequency converters for infinitely variable speed control, allowing continuous adaptation of fan speed to gas density and temperature
- Direct-coupled gas-tight encapsulated special motor with water cooling system
- This motor developed by Tenova LOI has become an industry standard because of its high performance and reliability

**High-performance recirculation**

- The recirculation fan motor developed by Tenova LOI in combination with the Tenova LOI high-performance fan impeller and the diffusor system ensures:
  - Maximum recirculation of atmosphere gas
  - Optimized plant capacity
  - Outstanding temperature uniformity

The high-performance fan developed by Tenova LOI ► for atmosphere gas recirculation is equipped with a water-cooled, gas-tight motor, variable frequency controlled, up to 55 kW. It is suitable for use with both nitrogen and hydrogen atmospheres.

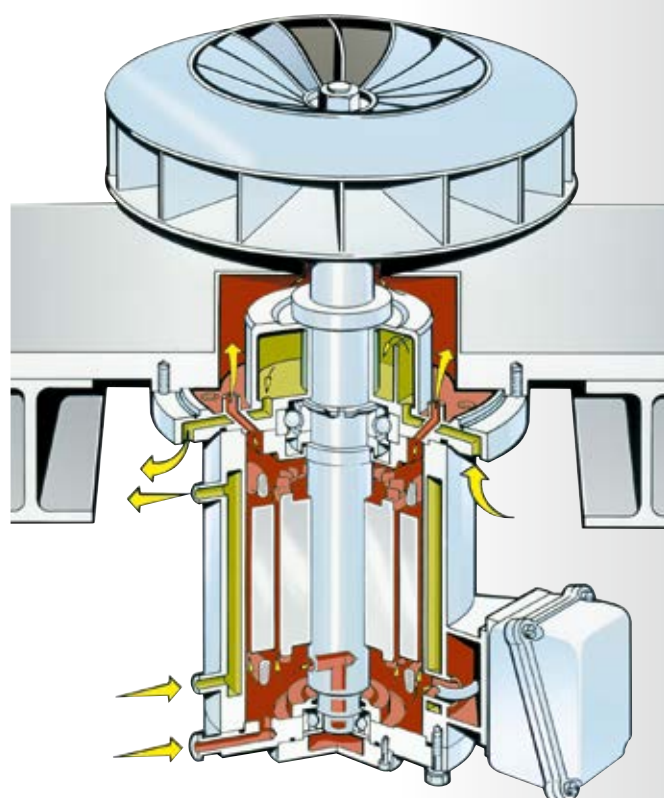

# The High Product Quality achievable with HPH® Technology

## Mechanical properties

The HPH® plant generation ensures outstanding mechanical properties, including:

- Complete recrystallization
- An extremely homogeneous microstructure with very low scatter of mechanical properties
- High elongation at rupture and low, homogeneous  $R_e$  and  $R_m$  values

## Grade designations for cold-rolled flat steel products

Ductile steels intended for cold forming

International Designation	2007 EN 10130	1991 EN 10130	1983 DIN 1623
CQ	DC01	Fe P01	St 12
DQ	DC02	Fe P03	RR St 13
DDQ	DC03	Fe P04	St 14
EDDQ	DC04	Fe P05	St 15
IF	DC05	Fe P06	IF 18

## Mechanical properties guaranteed by Tenova LOI Thermprocess in accordance with EN 10130 (2007)

Minimum requirements for cold-rolled flat annealed steel products intended for cold forming

	$R_e$ N/mm <sup>2</sup> max	$R_m$ N/mzm <sup>2</sup>	$A_{80}$ % min	$r_{90}$ min	$n_{90}$ min
<b>DC01</b>	280	270 to 410	28	–	–
<b>DC03</b>	240	270 to 370	34	1.3	–
<b>DC04</b>	210	270 to 350	38	1.6	0.180
<b>DC05</b>	180	270 to 330	40	1.9	0.200
<b>DC06</b>	170	270 to 330	41	2.1	0.220
<b>DC07</b>	150	250 to 310	44	2.5	0.230

## HIGH PRODUCT QUALITY

LOI HPH® technology ensures atmosphere dew points below  $-60$  °C. When annealing special grades, additional action can be taken to ensure dew points below  $-75$  °C. The extremely pure hydrogen annealing atmosphere and precise temperature control bring considerable quality benefits with a wide variety of steel grades.

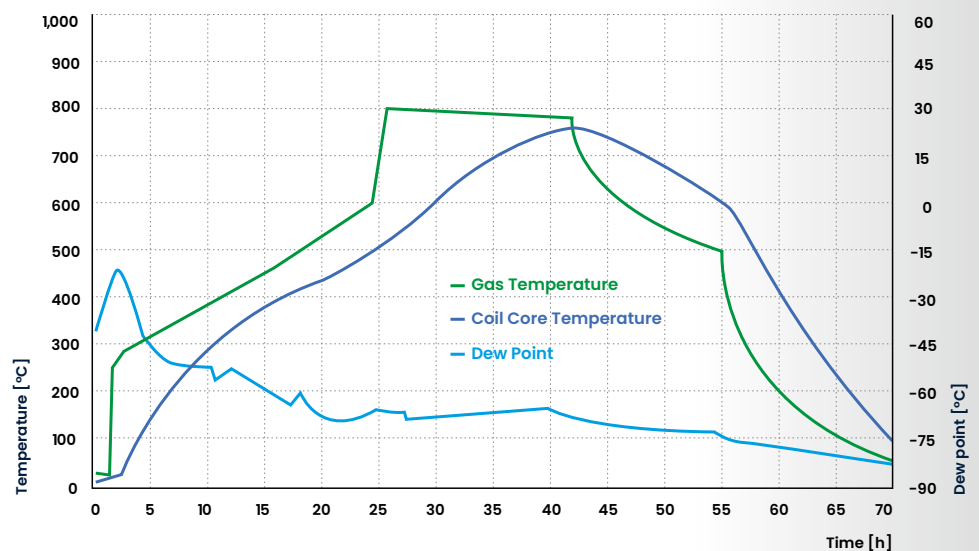

### Strip quality

Steel strip annealed in HPH® plants meets customers' most stringent requirements with respect to:

- The avoidance of carbon deposits
- The avoidance of surface decarburization, even with high-carbon steels
- The avoidance of surface oxidation, even with Cr and Si steels
- Corrosion resistance for phosphated and painted steel sheet
- Phosphating properties
- High surface quality, even for specially plated strip

### Our references

- All the leading car-makers use steel strip annealed in HPH® plants for exposed components – with considerable success
- Steel grades containing alloying elements with a high affinity for oxygen (Cr, Ni, Ti, Si), which are sensitive to high dew points can be successfully annealed in HPH® plants
- Considerable experience is available with the annealing of cold-rolled Cr steels in HPH® plants

### • Comparison data

- Comparison data confirming the special quality properties of steel strip annealed in HPH® plants is available from Tenova LOI Thermprocess on request

- ▼ Steel strip annealed using HPH® technology meets the highest requirements for surface quality. All the leading car-makers use steel strip annealed in HPH® plants for exposed components – with considerable success.



# Outstanding Safety

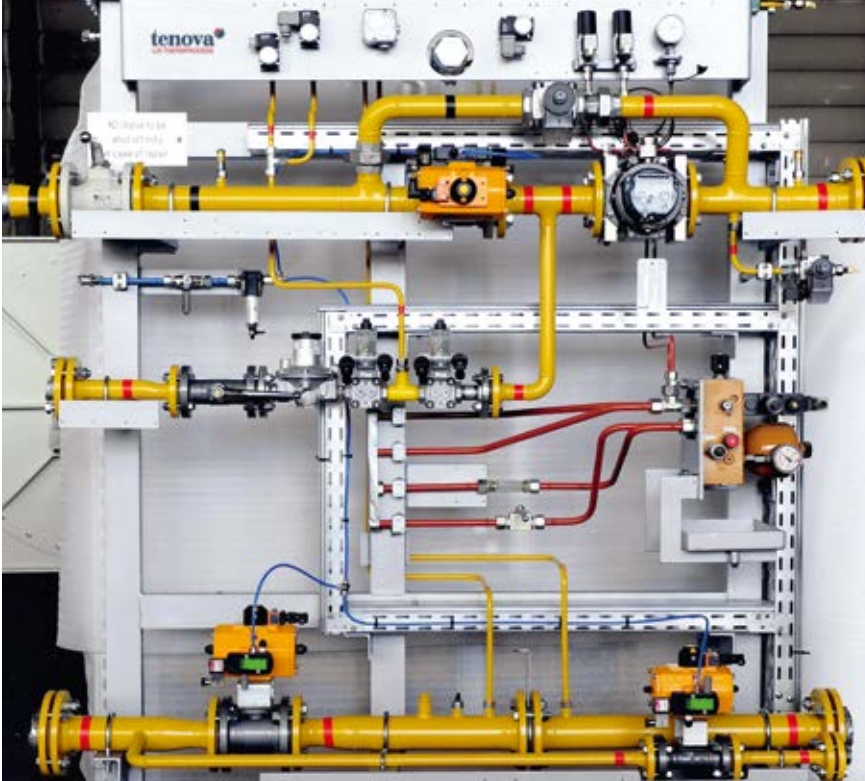

- ▲ Example of a modernized base
- ◀ Hydrogen and nitrogen valve stand

High safety standards are essential when hydrogen is used as an annealing atmosphere. In developing HPH® technology, Tenova LOI focused on the zero-error philosophy at the same time as building on existing furnace designs. As a result, even older Bell-type Annealing Plants can also be converted to HPH® operation.

## Plant safety features

- The annealing chamber is sealed solely at the bottom of the base
- The process gas supply system is equipped with a redundant configuration of safety-relevant valves and control components on the metering and pressure regulating station
- The control system has self-monitoring functions (watchdog shut-down, reference channel measurements, memory test)

- Safety-relevant status signals are interlocked independently of the PLC
- Continuous plausibility checking of status signals
- Continuous monitoring of pressures, flows and temperatures
- Monitoring of supply and disposal systems and activation of emergency control programs if necessary

## Process safety features

- The purge program is automatically adapted to the annealing process selected
- Sophisticated process control with plausibility checks, logging of malfunction signals and programmed safety reactions
- Actuators and sensors are function-tested before the start of each annealing cycle

- The inner cover/base assembly and all supply lines and valves are tightness-tested before and during each annealing cycle
- Three monitoring systems are active during the replacement of air by nitrogen
- Hot tightness testing of annealing chamber prior to removal of heating hood
- Monitoring for leakage during annealing and cooling phases
- Redundant pressure monitoring for hydraulic clamping of inner cover
- Hydrogen tight motors for the watercooled base recirculation fan and the air-cooled Bypass fan
- Monitoring of O<sub>2</sub> concentration during purging with a highly reliable oxygen sensor



# Modernization of Existing Plants

## Easy conversion from HN<sub>x</sub> to HPH<sup>®</sup>

- Are your energy costs too high?
- Is your plant capacity too low?
- Do you need greater flexibility in production?
- Are insufficient funds available for the construction of a new plant?

New purge gas and hydrogen piping, upgrading of the gas supply and

flue gas disposal systems and the installation of an HPH<sup>®</sup> safety system may already be sufficient to obtain similar performance to a new plant.

## Modernization of existing plant components

The first step must always be to analyse the existing plant precisely. If necessary, this analysis should also cover existing processes. Tenova LOI can then develop a tailor-made modernization program for equipment components or the control system, in order to obtain the benefits required.

Tenova LOI modernization programs may include:

- Replacement of cooling system
- Changeover to another fuel gas
- Modernization of existing recirculation systems
- Retrofitting of components to enhance performance and quality
- Application of newly developed process know-how
- Adaptation of existing plant components to latest standards
- Modernization of control systems
- Increasing the degree of automation

## Modernization of plants supplied by other manufacturers

- Modernization of control systems for other manufacturers' plants
- Integration of existing control systems from other manufacturers into an Tenova LOI overall control system
- Rehabilitation of annealing bases from other manufacturers and conversion to the tried and tested Tenova LOI base design

▼ Example of a modernized plant



# Excellent Economics

The special features of LOI HPH® plants and processes allow higher base performance than with other, conventional hydrogen annealing processes.

A further key objective of LOI HPH® technology is low consumption in hydrogen annealing.

## High efficiency

The following features ensure that HPH® plants are highly efficient:

- Individual recuperators with very high efficiency for each individual burner of the heating hood
- Highly effective convective heat transfer under the inner cover
- High-grade insulation ensuring minimal wall losses through the

heating hood and base as well as extremely homogeneous heat distribution over the entire height of the stack

- Selection of alternative cooling systems to ensure maximum efficiency evaluating existing surrounding conditions
- Precise process control for minimum process gas expenses
- Careful calculation of plant sizes and use of StackSet optimization software to ensure maximum possible use of space available

## Low consumption

- Efficient burners for very low fuel gas consumption
- Low density of hydrogen ensures low power consumption for 22 kW recirculation fan
- Purge gas optimization taking into account specific stack data for low nitrogen consumption
- Optimized purge programs as a function of rolling emulsion type, thickness of oil film and stack data, ensuring low hydrogen consumption
- Temperature-specific flow optimization for low cooling water consumption

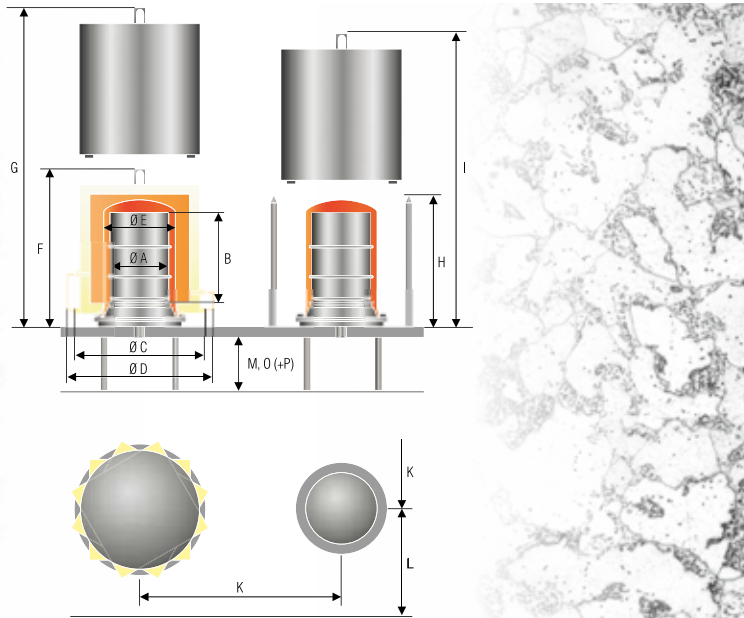

## Standard dimensions of gas-fired HPH® Bell-type Annealing Plants

Type HPH®	A	B <sup>1)</sup>	C	D	E	F <sup>2)</sup>	G <sup>3)</sup>	H	I	K	L	M <sup>4)</sup>	O <sup>5)</sup>	P <sup>6)</sup>
160 - 370	1600	3700	3150	3600	1800	6150	12100	5450	11300	5000	4500	2800	1500	500
185 - 460	1850	4600	3400	3850	2050	7000	13800	6350	13100	5500	4500	2800	1500	500
185 - 520	1850	5200	3400	3850	2050	7600	15000	6950	14300	5500	4500	2800	1500	500
200 - 520	2000	5200	3550	4000	2200	7650	15100	6950	14400	5500	4500	2800	1500	500
200 - 550	2000	5500	3550	4000	2200	7950	15700	7250	15000	5500	4500	2800	1500	500
220 - 520	2200	5200	3750	4200	2400	7700	15200	7000	14500	5700	4500	3000	1700	500
220 - 650	2200	6500	3750	4200	2400	9000	17800	8300	17100	5700	4500	3000	1700	500
270 - 520	2700	5200	4250	4700	2900	7850	15450	7150	14750	6500	5000	3000	1700	500

Details of intermediate sizes are available on request.

<sup>1)</sup> Max. stack height. Details of other stack heights are available on request

<sup>2)</sup> For each reduction of 100 mm in the stack height, the height is reduced by 100 mm

<sup>3)</sup> For each reduction of 100 mm in the stack height, the crane hook height is reduced by 200 mm

<sup>4)</sup> Recommended basement depth with Bypass cooling

<sup>5)</sup> Recommended basement depth with water spray cooling

<sup>6)</sup> Additional basement depth with flue gas extraction

### Typical performance and consumption data\*

Type	Annealing quality T (°C)	Coils per stack	Stack mass (t)	Cooling technology	Base capacity (t/h)	Fuel gas* (kWh/t)	N <sub>2</sub> purge gas (m <sup>3</sup> /t)	Electric power (kWh/t)
HPH* 160-370	700/690	7	37	JET	1.3	210	1.1	20.6
HPH* 200-460	710/680	7	68	BYPASS + JET	2.7	187	1.9	9
HPH* 200-520	710/620	4	90	SPRAY	2.89	164	1.1	6.3
HPH* 200-520	710/680	4	90	SPRAY	2.14	179	1.1	8
HPH* 220-520	660/640	4	100	SPRAY	2.47	167	1.1	7
HPH* 220-650	710/680	5	121	SPRAY	2.49	176	1.1	7

\* Fuel gas consumption for standard equipment. Energy saving options: enlarged recuperators 10 % savings potential, charge preheating 20 % savings potential, hot water supply 15 % savings potential.

Hydrogen consumption approx. 1.5 to 3.0 m<sup>3</sup>/t, depending on rolling emulsion type, amount of incoming oil and iron fines on the strip, strip thickness, annealing quality required. Savings potential by hydrogen recycling 80 %.

- ▼ Bell-type annealing plant (type HUGF 210-520 HPH) for annealing wide strip coils for the automobile industry, capacity 400,000 tonnes per year, equipped with water spray cooling system.



# Training, Resesarch and Development

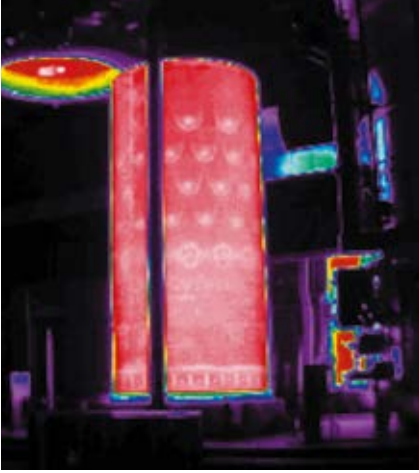

At Tenova LOI, new developments are always verified by model calculations and tried out in a comprehensive series of test annealing cycles to ensure that they are fit for use in practice. Customers can therefore be sure that Tenova LOI products are both extremely innovative and highly reliable.

Tenova LOI has access to several HPH® plants for trials under cooperation agreements with customers. These are not shielded

laboratory installations but typical production facilities operating under real production conditions when no tests are in progress. These plants are equipped with all the instruments required to test and demonstrate annealing cycles.

Training and familiarization programs ensure that customers have all the know-how they need for the successful operation of Tenova LOI plants. Tenova LOI training covers both hardware operation and process know-how.

- ▲ Thermographic measurements for the determination and optimization of heat transfer coefficients

## ANNEALING PROCESS

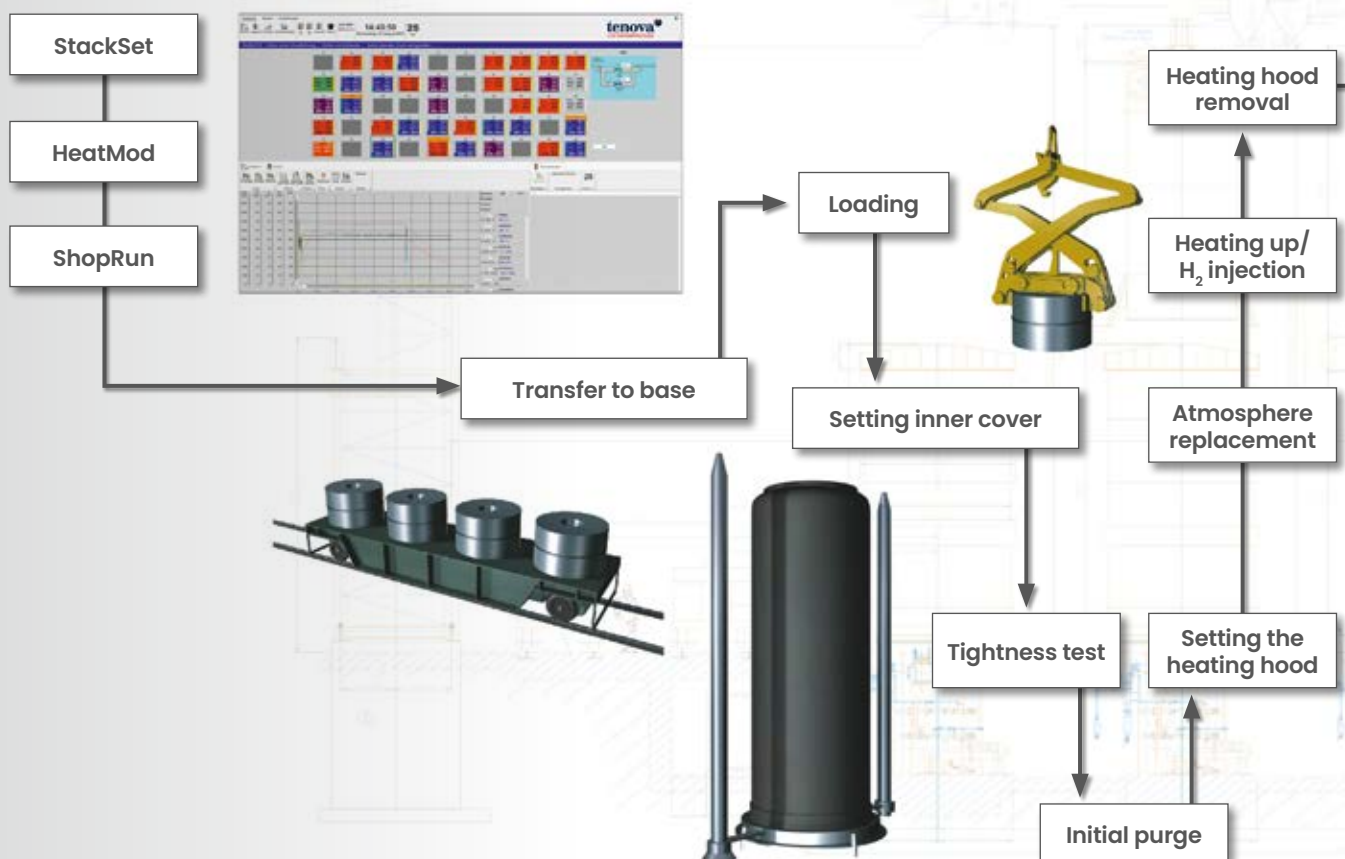



### Development projects

- Patented high-speed final purge process for enhanced safety (EP 0 714 452 B1)
- Energy efficiency improvement
- Detailed improvement of atmosphere replacement stages (air-nitrogen-hydrogen-nitrogen-air) of annealing cycle
- Adaptation of annealing and purge parameters to the requirements posed by new rolling emulsions with a view to improving strip cleanliness
- Development, optimization and introduction of a Jet cooling hood (EP 0 894 150 B1)

- Optimization of recirculation system including fan impeller and motor
- Hydrogen recycling
- Optimization of recirculation fan/diffuser system for steel sheet and wire annealing plants
- Optimization of heating system
- Mathematical model for sticker reduction

The patented (EP 0 714 452 B1/ US 5 7340 930) LOI high-performance purge system for faster atmosphere replacement (to 2 % hydrogen in 12 minutes with the recirculation fan stopped)

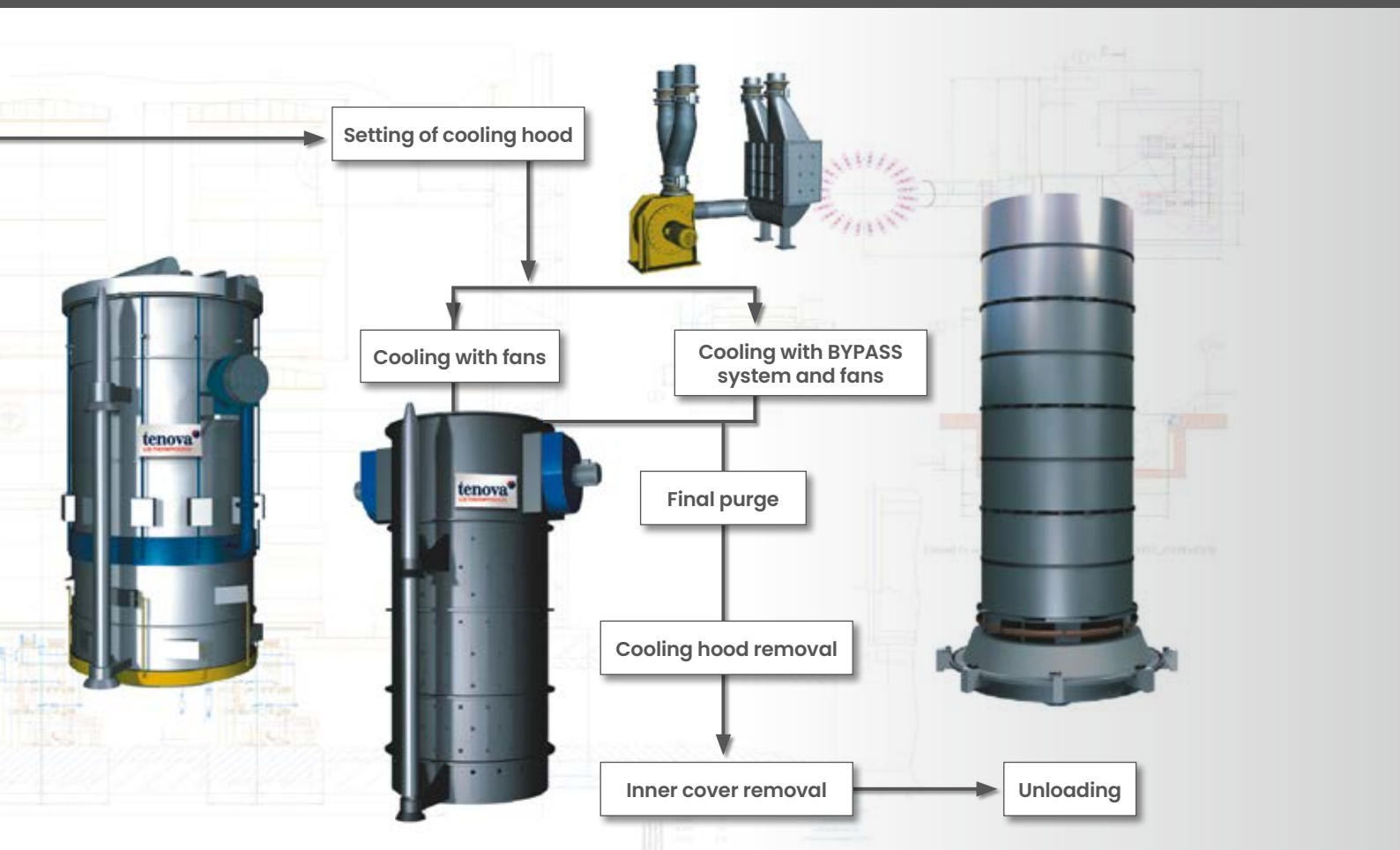
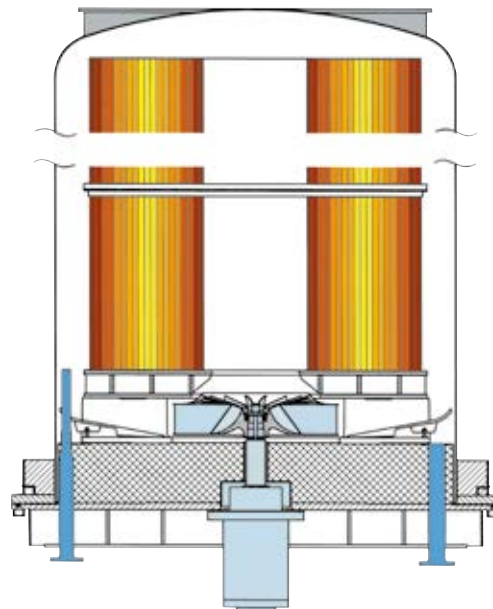

# The Heating Hood

## THE HEATING HOOD

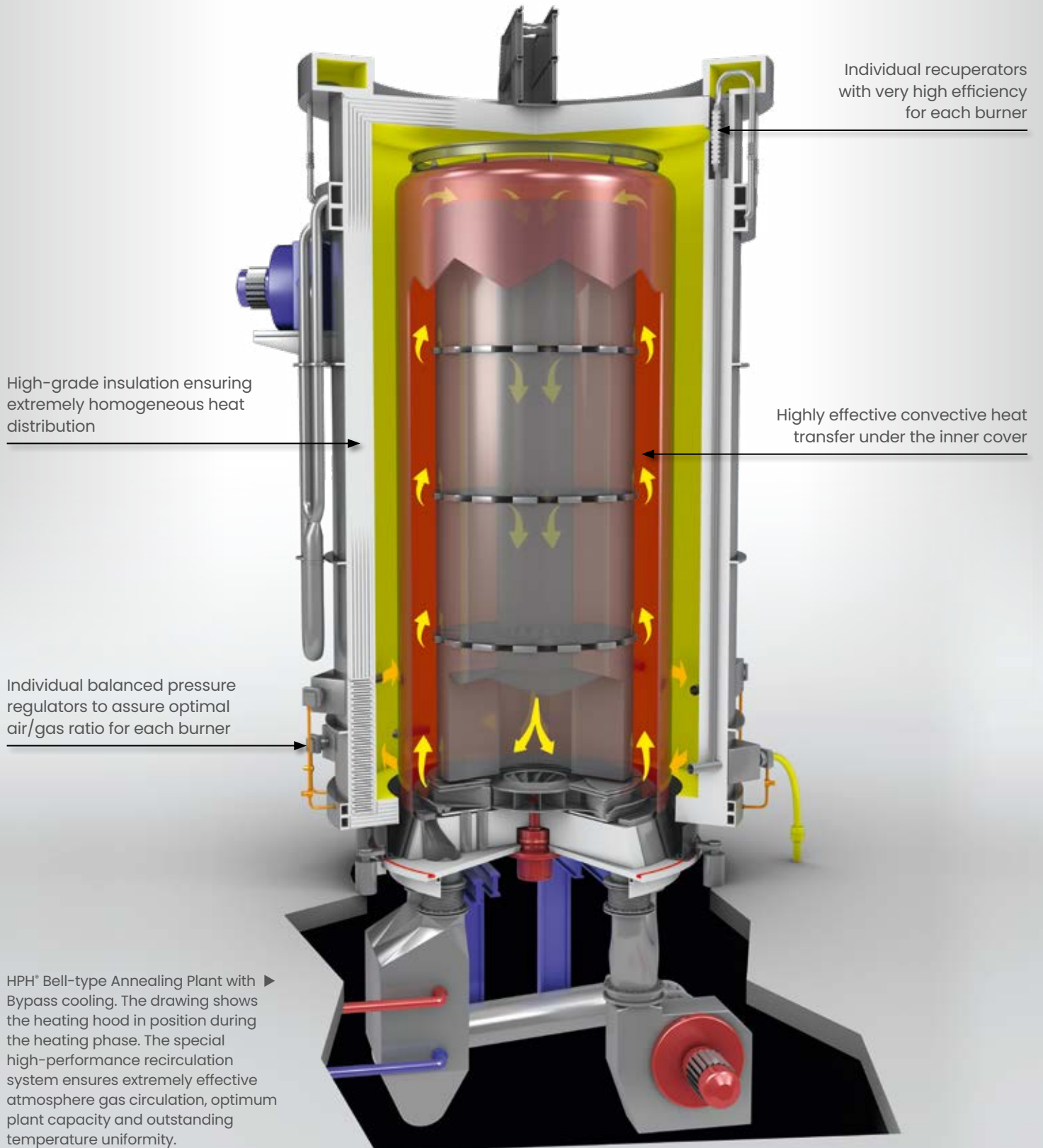

HPH® plants feature optimized atmosphere gas flow during heating and cooling. Two or three thermocouples with associated instrumentation and control systems provide precise control of the temperature under the inner cover and reliably protect the charge material against overheating during the annealing process.

### Heating hood

The heating hood may be heated either by burners or by an electric heating system. Burners for natural gas, coke oven gas, low caloric gas and light diesel oil are available. High-grade insulation minimizes heat losses at the same time as ensuring very homogeneous temperatures over the entire height of the stack.

A hydrogen atmosphere combined with high performance recirculation systems makes for rapid heat transfer to the charge, allowing high heat input values and burner ratings. The short annealing times which are possible mean that energy consumption is reduced to

a minimum. With advanced burners, highly effective on-off control and process firing systems, HPH® plants reliably comply with applicable emission limits throughout the annealing cycle. Depending on the size of the plant, the heating hood may be equipped with 6, 9 or 12 burners.

### Hydrogen afterburning

Considerable amounts of oil vapour are produced during the annealing of steel strip which was rolled using oil. The same applies if emulsion has been used. Tenova LOI HPH® technology allows this vapour to be combusted in an environmentally compatible way.

One of the burners of the heating hood is specially designed for post-combustion of hydrogen loaded with oil vapour. This approach ensures that emission values are considerably below the maximum levels allowed. A process developed by Tenova LOI prevents the fouling or blockage of the hydrogen burner by condensing oil vapours.



▲ Heating hood of an HPH® plant – special fibre insulation for very low heat losses and low NO<sub>x</sub> burner technology



▲ Ultra low NO<sub>x</sub> HPH® Flameless heating hood

## HEATING HOOD ALTERNATIVES

### Low NO<sub>x</sub> heating hood

- Up to 12 specially designed low NO<sub>x</sub> burners per hood
- Dedicated internal recuperators for each burner for combustion air preheating up to 400 °C
- Dedicated balanced pressure regulators for each burner ensuring optimal air/gas ratio
- NO<sub>x</sub> emission below 250 mg/m<sup>3</sup> average over heating cycle

### Ultra low NO<sub>x</sub> heating hood

- 6 ultra low NO<sub>x</sub> burners with patented LOI flameless combustion technology
- 2 central, external recuperators for combustion air preheating up to 600 °C
- Up to 12 % fuel gas savings compared to standard heating hood
- NO<sub>x</sub> emission below 100 mg/m<sup>3</sup> average over heating cycle

## The Annealing Base



◀ The diffuser, which is manufactured from high-temperature-resistant cast steel, is divided into four sections, allowing free thermal expansion and preventing horizontal forces in the structure.

recirculation fan, the design ensures maximum circulation of the atmosphere gas.

The design of the annealing base warrants extremely clean annealing atmospheres over a practically unlimited service life.

The annealing base is optimized for obtaining the lowest dew point possible and is even suitable for annealing cold-rolled Cr steels.

This design effectively seals the annealing atmosphere from the surrounding air and offers a practically unlimited service life without need for continuous maintenance, in contrast to other annealing base designs.

The base plate of the annealing base, with individual supports and loose encapsulation, has been tried and tested in thousands of practical applications.

A key element in ensuring product quality in an HPH® facility is the flow of the atmosphere gas during heating and cooling. Atmosphere gas

flow paths have been continuously optimized in comprehensive practical tests conducted in cooperation with a fluid mechanics institute.

The gas guide system optimized for ideal flow conditions is made from special high-temperature-resistant CrNi castings. Together with the special high-performance

▼ The HPH® base design effectively seals the annealing atmosphere from the surrounding air and offers a practically unlimited service life without need for continuous maintenance, in contrast to other annealing base designs.

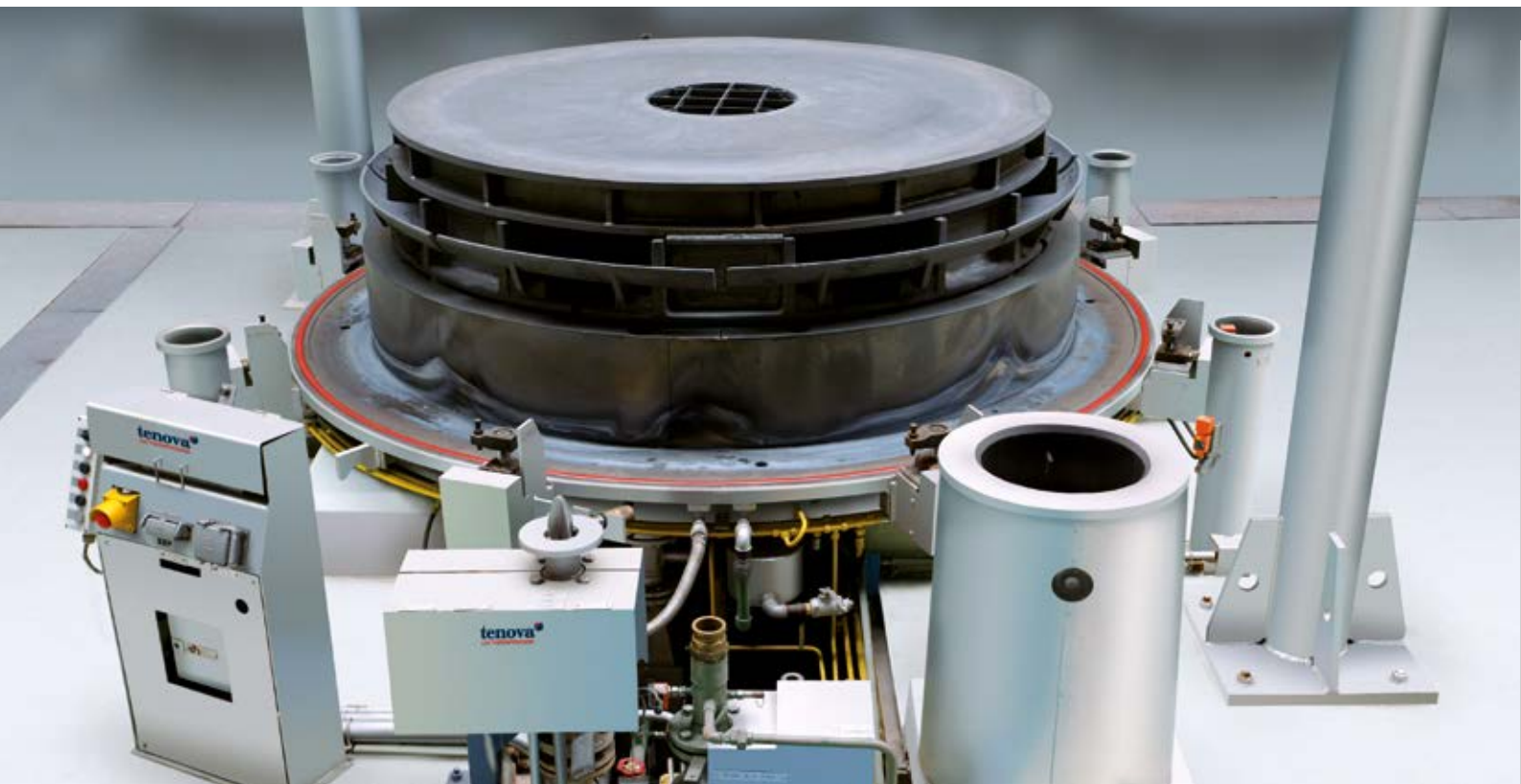

# The Cooling Systems

On the basis of its extensive plant and process expertise, Tenova LOI Thermprocess can offer a variety of cooling systems and supply the ideal cooling system for any application.

Tenova LOI has already supplied a large number of plants with each type of cooling system. All the systems available allow the optimized utilization of all equipment components for annealing, cooling, charging and discharging without idle times. The combination of Bypass + Jet cooling systems is the version which ensures the highest performance, allowing a reduction of up to three hours in cooling time compared with water spray cooling. Despite the higher initial cost, the combination of Bypass + Jet cooling systems is the most cost-effective variant in overall terms. Jet cooling and water spray cooling may be attractive alternatives for smaller plants and larger plants respectively.



▲ HPH® Bell-type Annealing Furnace Plant for cold rolled steel strip

## THE COOLING SYSTEMS

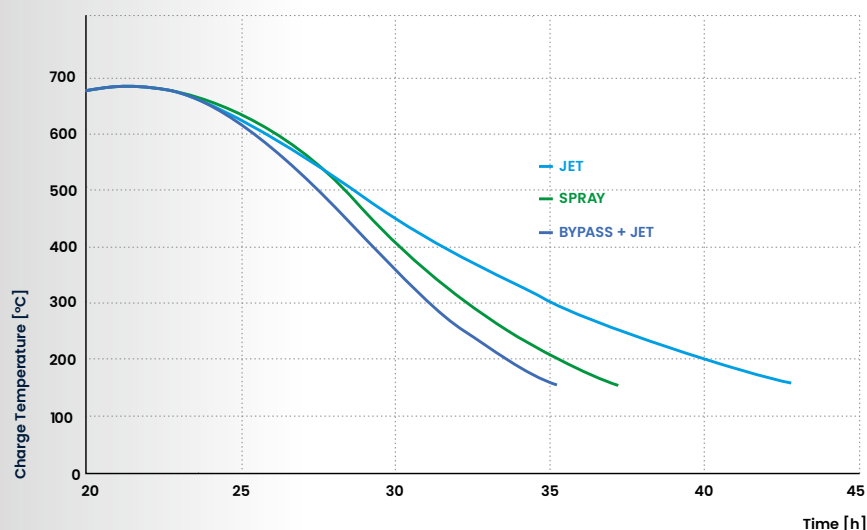

**Jet cooling**  
**Water spray cooling**  
**Bypass + Jet cooling**

The criteria for the selection of the ideal cooling system are as follows:

- Annealing time or ratio of annealing and cooling times
- Heat treatment process required
- Quality of cooling water available
- Ratio of stack mass to inner cover surface area
- Existing infrastructure (i.e. Cellar)
- Total cost

◀ Cooling curves with different cooling systems

# Water Spray Cooling

The atmosphere gas under the inner cover is cooled by spraying water onto the outside of the inner cover. Over the past 30 years, this technology has been successfully used by Tenova LOI on more than 1,500 annealing bases.

## Water Spray Cooling

In order to prevent excessive steaming in the annealing shop and severe corrosion of the inner cover, the inner

cover is cooled to between 120 °C and 160 °C using the integrated air cooling system before the water spray system is switched on.

Water spray cooling calls for a corrugated inner cover to improve stability of the water film. Depending on the cooling water quality, the service life of the inner cover with this type of cooling system is between 500 and 1,400 annealing cycles.

## Advantages of Water Spray Cooling

- Simple, cost-effective process
- Lower free volume and thus, lower consumption of protective gas
- Lower specific power requirement for cooling air fans
- High cooling power with open cooling water cycle
- No basement is required (this may, however, be a disadvantage from the maintenance point of view)

## Prerequisites

Very high-quality water meeting the following requirements is needed:

- Chloride and sulphate concentration lower than 70 mg/l
- Conductivity lower than 500 µS/cm

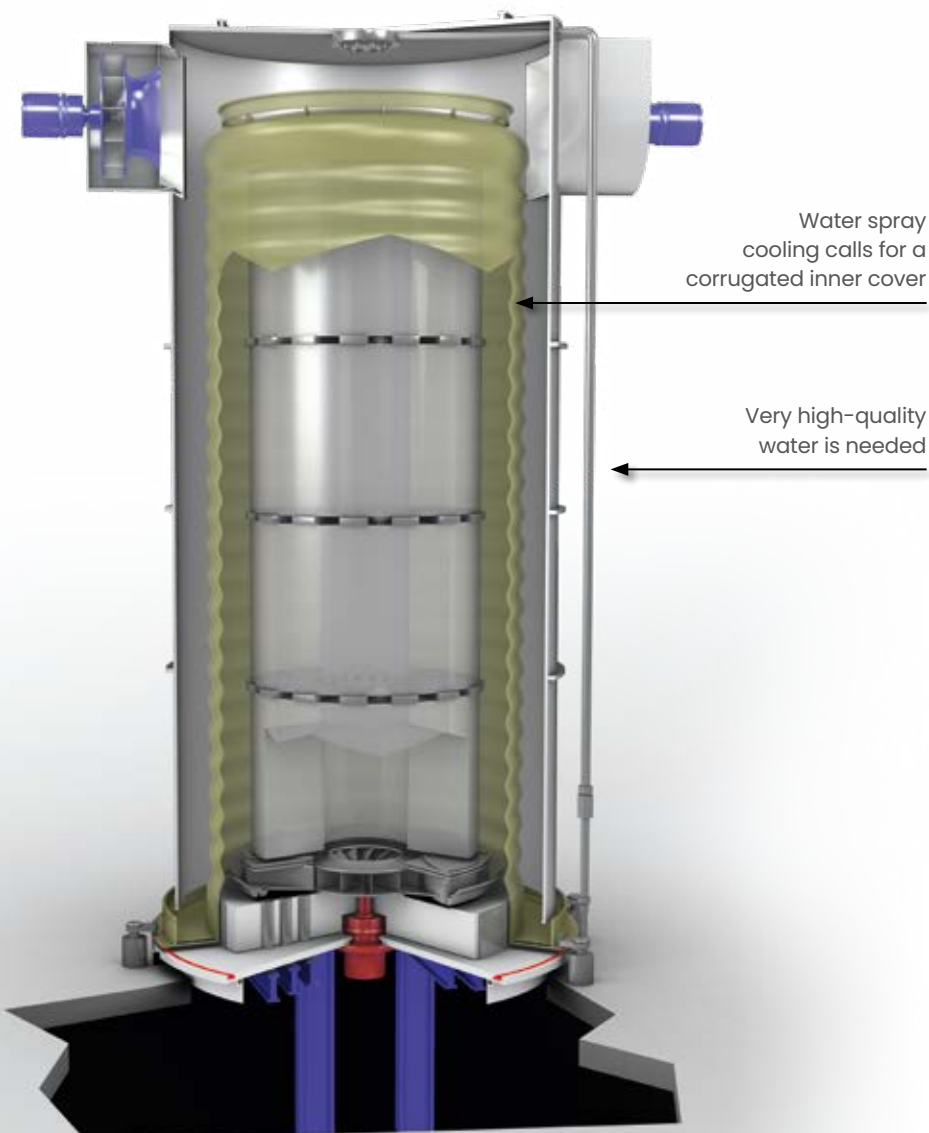

▲ HPH® plant with water spray cooling system

◀ Water spray cooling process

# Bypass Cooling

Tenova LOI has already installed this low-maintenance cooling system on more than 4,500 annealing bases and it has proved itself in practice at customers' plants for more than 50 years. For improved cooling performance, a Bypass cooling system is usually combined with Jet cooling.

## Bypass Cooling

While the main flow of atmosphere gas is recirculated under the inner cover, part of the gas flow is passed through a gas/water heat exchanger under the annealing base, where it is cooled. The cooling power of the Bypass cooling system is infinitely variable. In addition, the inner cover is cooled from the outside by cooling fans.

Bypass cooling uses the cooling surface of the external heat exchanger (more than 200 m<sup>2</sup>) for heat transfer.

With this type of cooling system, inner covers have a long service life of more than 1,400 annealing cycles. Smooth inner covers may be used, ensuring easy, low-cost maintenance.



▲ LOI developed Bypass cooling system featuring dual cooler installed in the basement

Bypass cooling process ►

## Advantages of Bypass Cooling

- Infinitely variable cooling performance
- No exposed water or steaming (increasing humidity) in the annealing shop
- May be combined with an air cooling hood (preferably a Jet cooling hood) for additional cooling of inner cover surface
- No need for emergency power supply for cooling hood fans in the event of power failure
- Sophisticated energy recovery measures possible
- Cooling performance 10 to 20 % higher than with spray cooling
- Less stress on plant (significantly longer inner cover service life than with water spray cooling)
- Possibility of using a closed cooling water cycle with reduced corrosion on cooling water pipework
- Lowest overall cost over a period of 10 years, taking into account capital cost and operation and maintenance expenses

Smooth inner covers may be used, ensuring easy, low-cost maintenance

Part of the gas flow is passed through a gas/water heat exchanger under the annealing base

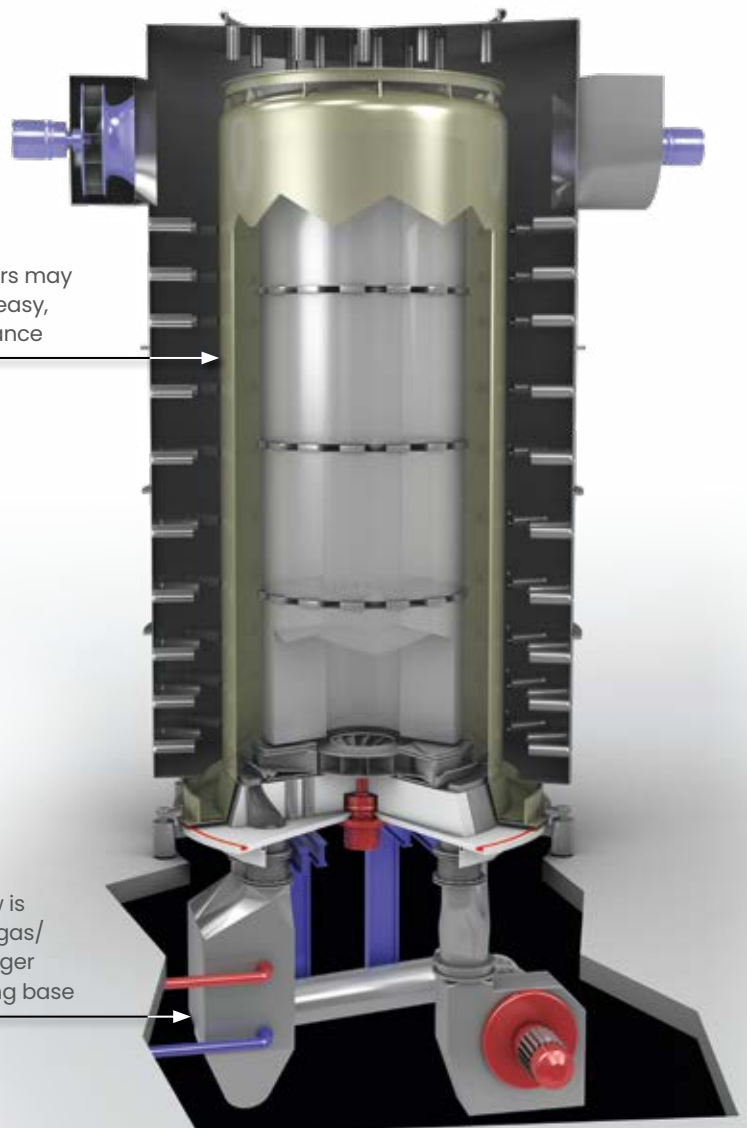

# Jet Cooling

Jet cooling is an attractive alternative for facilities where the high-quality water supply needed for water spray cooling or the basement needed for Bypass cooling are not available. This type of cooling system is especially well suited for plants with long heating times (e.g. for spheroidizing or high-temperature processes). To date, Tenova LOI has installed more than 500 annealing bases with Jet cooling systems.

The Jet cooling hood developed by LOI is patented (EP 0894150, US 6177044). Cooling is provided by air jets targeted directly at the outside of the inner cover. These jets are generated by a large number of air nozzles installed at the outside surface of the steel casing of the Jet cooling hood. For highly effective cooling, nozzles of different diameters with different spacings are distributed over the height of the cooling hood.

In addition, the top of the hood also has a large number of air nozzles for intensive cooling in this area.

Two to three radial-flow fans extract air from the cooling hood. Compared with a parallel-flow air cooling hood, heat transfer with a Jet cooling hood is three times more intensive, while noise emission is significantly reduced.

Jet cooling hoods are an attractive alternative for improving the performance of existing Bell-type Annealing Plants.

## Advantages

- Relatively low capital cost
- No cooling water required
- Optimized nozzle configuration, ensuring homogeneous cooling of all coils
- Low noise output
- 10 % capacity increase for existing plants

For improved cooling performance, the inner and outer surfaces of the cooling hood may be coated using a special paint with the following properties:

- High heat emissivity
- High thermal conductivity
- High adhesion

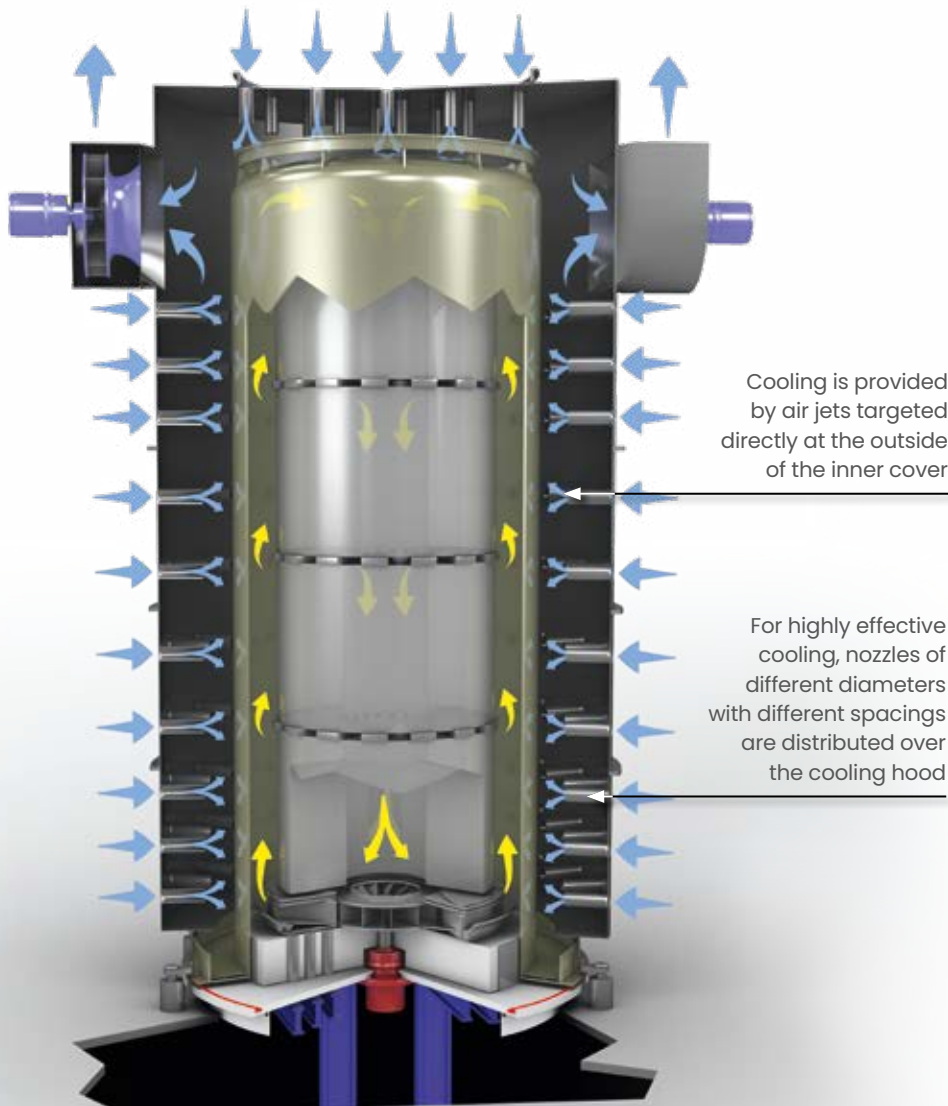

▲ Jet cooling hood following removal

◀ Jet cooling process



# Final Cooling

In order to prevent surface oxidation, the coils are cooled to the required skin pass temperature of about 40 °C, on final cooling stands. Tenova LOI has developed coil cooling and storage units (CCSU) which offer final cooling with dried air.

## Final cooling in dried air

Following unloading from the annealing base, the stacks are positioned on special cooling stations and covered by lightweight hoods. Dry cooling air flows through ducts (preferably located underground) to the cooling stations, thus cooling the stack. The heated air then passes through a recirculation fan and a cooler. The humidity of the main air flow is

kept low by the continuous addition of dried makeup air. The air required may be dried either cryogenically or by absorption. Absorption using a lithium chloride solution has proved to be an effective approach. Where steam is not available, cryogenic drying may be used.

## Advantages

- Avoidance of corrosion during final cooling and storage
- Lower overall cost compared with final cooling on annealing base
- Combination of final cooling and storage prior to skin pass temperature
- Greater flexibility for annealing shop and skin pass/temper mill



▲ Coil Cooling and Storage Units (CCSU) offering final cooling with dried air

## FINAL COOLING

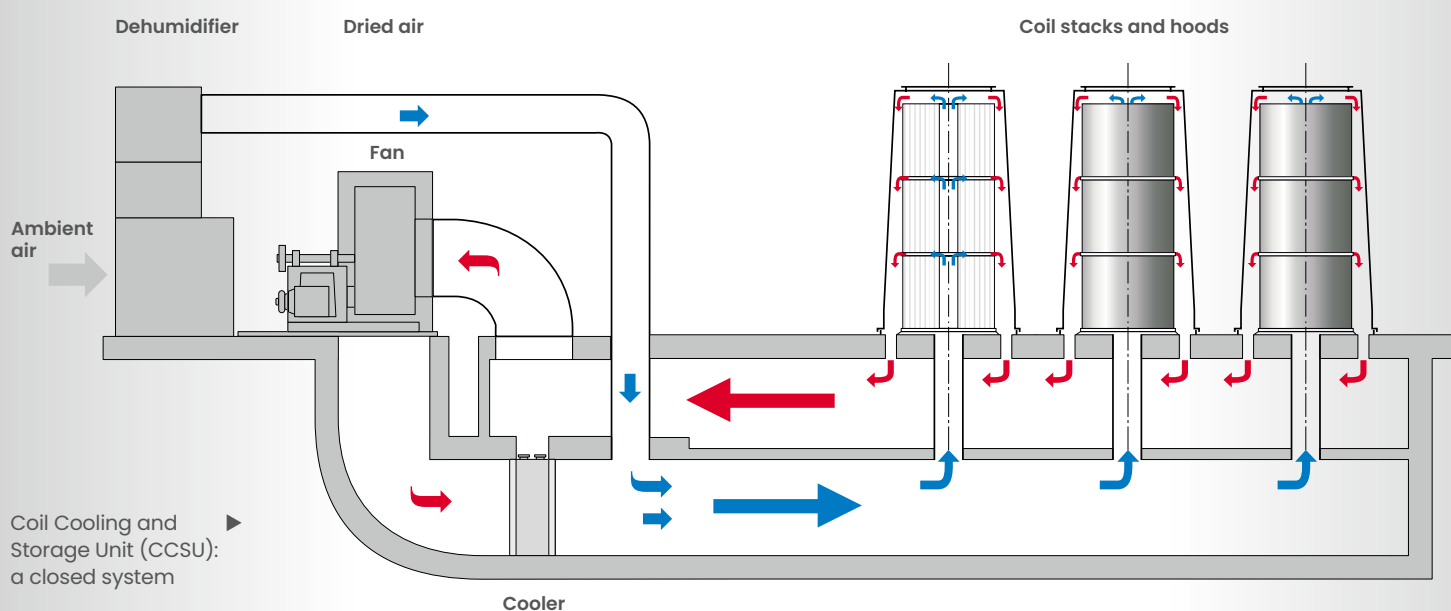

# Energy Saving Possibilities

## HEATING PHASE

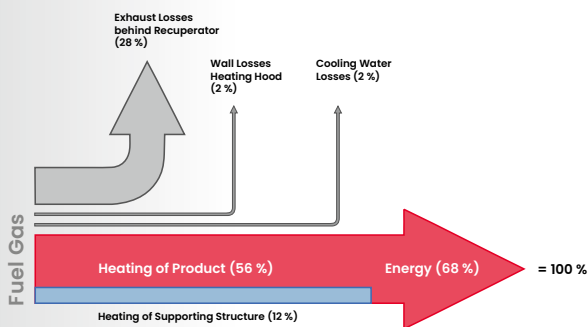

## COOLING PHASE

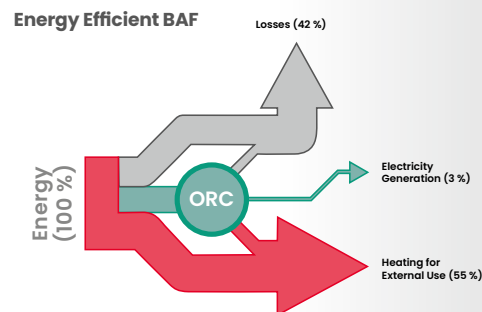
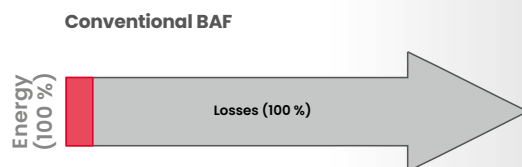

The heat balance during the heating phase clearly shows that significant improvements to the energy efficiency of modern Bell-type Annealing Plants can be achieved only by ensuring more efficient use of energy for heating the charge and by reducing flue gas losses. Reductions in the energy required for heating the charge are subject to certain limits connected with stable operation of the plant. In addition to fuel costs, the cost of electric power, nitrogen and hydrogen must also be taken into consideration.

The Bypass cooling system used for the Energy Efficient BAF is a two-phase cooling system. A few minutes after the start of the cooling phase, the "gas/thermal oil" cooler is switched on at approx. 700 °C. A circulation system feeds the thermo-oil which was heated to more than 250 °C to a subsequent ORC process (OCR = Organic Rankine Cycle); electrical power is generated by a piston expander. In order to increase the relatively low efficiency of the ORC process, hot water – in addition to the electrical power – is generated and fed to a hot water circuit. As soon as a gas

temperature lower than 300–350 °C has been reached in the Bypass system, the cooling system is switched to a second gas/water cooler. Hot water with a temperature of approx. 80 °C is extracted and fed to a hot water circuit.

Energy for heating is no longer completely dissipated during the cooling process and discharged via cooling water. With this solution, up to 58 % of the energy stored in the stack and support structure after the heating cycle can be recycled, provided that hot water at a temperature of 70–80 °C can be used at the plant.

### Use of heat from cooling for hot water generation

Plants with a traditional Bypass cooling system equipped with one heat exchanger per base only, can also be designed to allow the use of heat from the charge rejected via the cooling water. In the case of a plant with eight annealing bases, for example, 500 kW of hot water at a temperature of 80 °C can be produced almost continuously.

### Hydrogen recycling with gas treatment

Even with optimized gas injection cycles, hydrogen is a significant cost factor in Bell-type Annealing Plant operation. It is currently normal practice for the hydrogen, which has been contaminated with oil vapour, to be fed to a special hydrogen burner installed in the heating hood, where it is combusted without residue.

In hydrogen recycling, the first process stage is to remove rolling oil residue and particulate matter from the used hydrogen. Other gases are then filtered out by pressure-swing absorption and the recycled hydrogen is dried. With this process, it has been shown that some 70 to 80 % of the hydrogen used at a plant can be recycled and returned to the plant as fresh gas via a buffer tank. However, acceptable payback periods can only be achieved at large annealing plants with at least 30 bases or an average total hydrogen consumption of about 150 m<sup>3</sup>/h.

- ▼ Energy efficient BAF with dual Bypass heat exchangers per base, allowing heat recovery by thermal oil and hot water

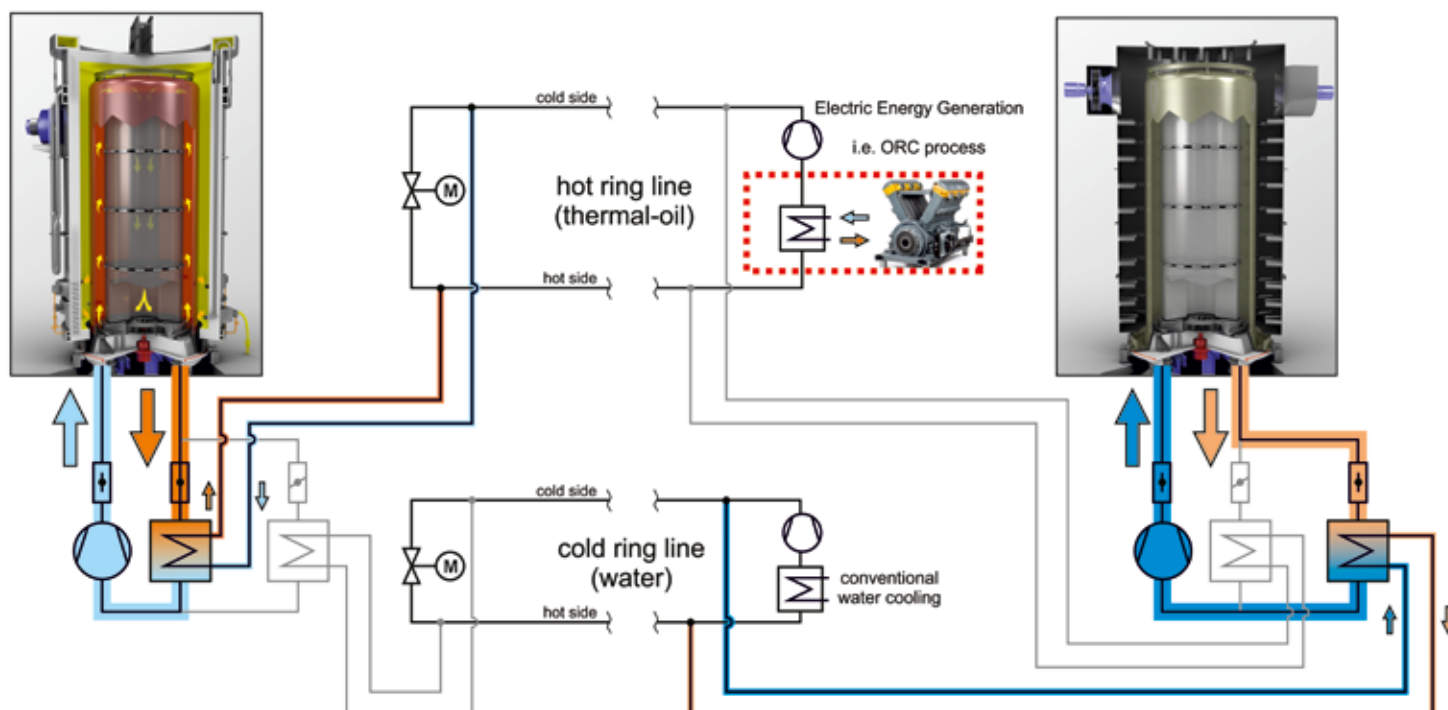

# Bell-type Annealing Furnace Plant with Fully Automated Crane Operation



- ▲ The multi-media coupling automatically establishes all connections for the gas supply (NG, H<sub>2</sub>) and the electrical signals.
- ◀ This batch annealing plant at a German cold rolling mill is the world's first featuring fully automatic crane operation. Its innovative energy management and heat recovery concept also make it the most energy efficient plant of its kind in the world.



The world's first Bell-type Annealing Plant with fully automated crane operation was installed by Tenova LOI Thermprocess at a German cold rolling mill. The coils, convector plates and all hoods and covers are handled in a fully automated process. For this purpose, a specially designed plant system and error-proof communication with the crane were essential. In addition, special attention was paid to energy efficiency.

### Optimized material flow

The production of cold strip products of top quality requires diligently coordinated process steps. A fully automated operation goes along with precise control of all defined process parameters, uninterrupted monitoring and documentation as well as optimized material flow.

The plant control system at the German cold rolling mill is linked with their production data acquisition systems. It coordinates the transport and storage of the coils, hoods and convectors. The integrated warehouse management assigns storage places to the coils. It generates and sends the corresponding travel orders to the crane control system. In doing so, the warehouse management system takes into account storage rules, such as the maximum stacking height, and performs plausibility checks.

### High level of automation

The annealing plant is the first in the world to operate with automated crane movements. The two-beam overhead travelling crane transports the coils, convectors as well as the heating and cooling hoods. Only

one person is needed to monitor the crane operations from the control room. As the system works without any intervention by man, the tongs feature sophisticated sensing equipment, such as distance and tilt sensing devices as well as laser light sensors for controlling the gripping operation. An RFID antenna receives signals containing the hood numbers sent out by RFID chips installed in the hoods. Redundant, two-channel absolute position encoders determine the positions of the crane, the trolley and the lifting gear. The high precision of the transducers allows them to determine the position of the gripper with a tolerance below  $\pm 15$  mm. The swing damper is a camera-guided system. The camera focuses on a hairline cross on the gripper.

The plant complies with all requirements stipulated in the applicable regulations, for example in DIN EN 13135. The entire annealing shop area is surrounded by a protective fence containing nine protective doors.

### Most energy efficiency

The fuel consumption at this most modern annealing shop is about 11 % lower than in the case of a conventional plant design. As part of a comprehensive energy management system the excess energy is decoupled and made available to other energy using units within the works either as electricity or heat. The heat is extracted from the coils and transferred to a thermal oil by means of hydrogen. The oil, which attains temperatures of up to 270 °C, is an ideal medium for evaporating ethanol in an Organic Rankine Cycle plant which converts heat into electric power.

- Automatic crane operation (unmanned)
- Automatic charging/discharging of coils connectors or coil + convector units
- Automatic charging/discharging of inner covers, heating hoods and cooling hoods
- Automatic connection/disconnection of all media (natural gas, hydrogen, electricity)
- Automatic coil storage management for complete material tracking
- Large central recuperators for combustion air preheating up to 600 °C
- Control system with failsafe technology

Phase	Year	Number of bases
I	2012	12
II	2015	4
III	2018	8
Total		24

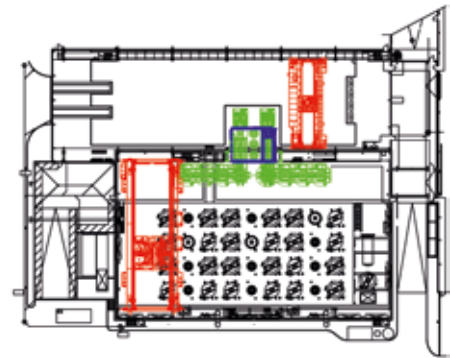

- ▼ This natural-gas-heated HPH<sup>®</sup> batch annealing facility comprises 24 bases with 14 heating and 6 Jet cooling hoods. It is currently the most advanced Bell-type Annealing Furnace Plant in the world. It anneals fully automatic hot and cold-rolled medium-wide strip coils weighing up to 15.4 t. The outside coil diameters range between 1,000 and 2,000 mm. The coils are 150 to 650 mm wide.



# THE UNSURPASSED CONTROL CONCEPT

Fully automated control systems are indispensable.  
Modern control systems ensure:

- High safety
- Optimized processes
- Constant, high product quality
- High plant availability
- High productivity
- Optimum conditions for operation and maintenance
- Minimal energy and utility consumption
- Lower pollutant emissions

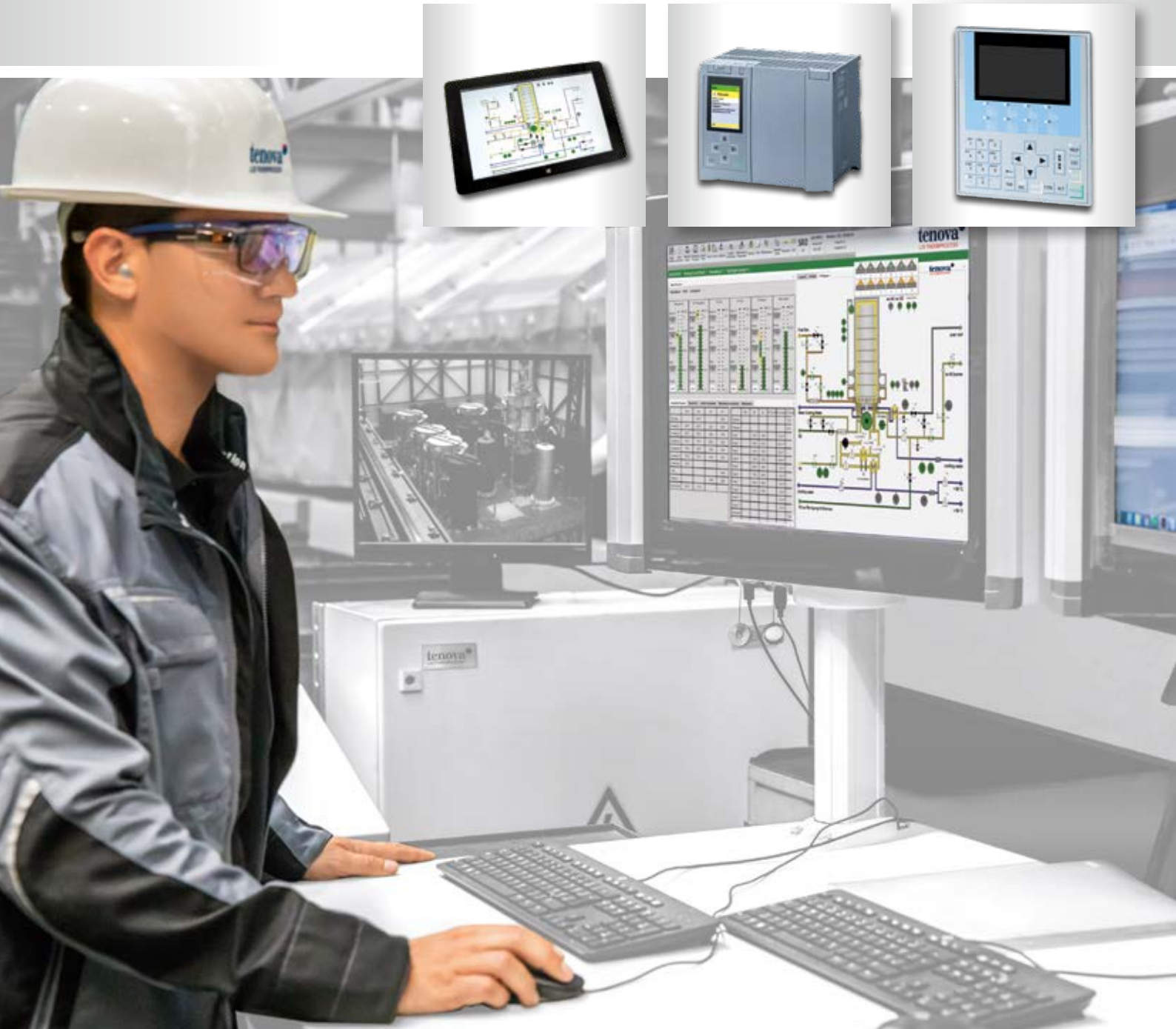

Tenova LOI offers control systems including all the hardware and software required from the switchgear assembly to the supervisory control system.

### SWITCHGEAR ASSEMBLIES

Tenova LOI designs and supplies switchgear assemblies to international standards as key components of turn-key instrumentation and control systems. The assemblies are planned and designed using advanced CAD workstations with EPLAN, AutoCAD, etc.

The equipment available includes

- Conventional, freely wired switchgear assemblies
- MCC systems based on modules or withdrawable units
- Special designs in accordance with customers' requirements

### CONTROL SYSTEMS

Control systems for HPH® Bell-type Annealing Plants usually consist of two levels:

- One control unit per base (individual base control)
- One overall supervisory control system for all the bases

The individual base control units and the ProView®.NET supervisory control system together form a

harmonized system for the optimized control of a HPH® Bell-type Annealing Plant. The base control units and the higher level supervisory control system are linked via an Ethernet network.

Bell-type Annealing Plants have been implemented with a number of different control systems, including the following:

- Siemens S7 Family
- Allan Bradley series 5/SLC
- General Electric series 90
- Yokogawa Centrum XL
- ATS 500/700

### FEATURES OF ALL HPH® BASE CONTROL UNITS

- Autonomous control unit with connected emergency operation panel
- Menu-based operation screens for all commands and setpoints
- Comprehensive library for storage of all annealing programs required on the control unit
- Control of entire process, including all safety functions
- Multi-stage program generator for temperature and gas flow rate control
- Output of all process data and indication of required and actual data (temperatures, flow rates and times) on the display

- Interim storage of annealing data in memory
- Detailed monitoring of annealing process with approx. 500 different status indications
- Alarm system with detailed structure (about 400 different alarms)

In addition to the control systems mentioned above, Tenova LOI also supplies the ATS 700 individual base control unit.

### COMPACT CONTROL UNIT ATS 19" MODULE

Apart from standard control units, Tenova LOI also offers customer-specific control units as 19" modules for the modernization of existing plants.

These customer-specific variants are based on Step 7-compatible control units and are configured and programmed to replace the existing control units (MCS, ATS 300, ATS 500, ATS 700, ...) without any rewiring of input or output signals.

More than 2,200 control modules of this type are now in service throughout the world.



## ProView®.NET – THE USER-FRIENDLY SUPERVISORY CONTROL SYSTEM

The high-performance ProView®.NET supervisory control system controls the entire process in Bell-type Annealing Plants with several bases, including plants completed in several stages. Various additional modules are available to optimize the throughput of each individual base or the whole plant. The new ProView®.NET control system for Bell-type Annealing Plants is a further development of the tried and tested ProView system using the latest programming languages and operating systems. The latest version of ProView®.NET is based on Microsoft's .NET-Framework, making programming largely independent of the software used.

Current operating system:

MICROSOFT Windows  
with .NET-Framework 4

MICROSOFT Windows Server

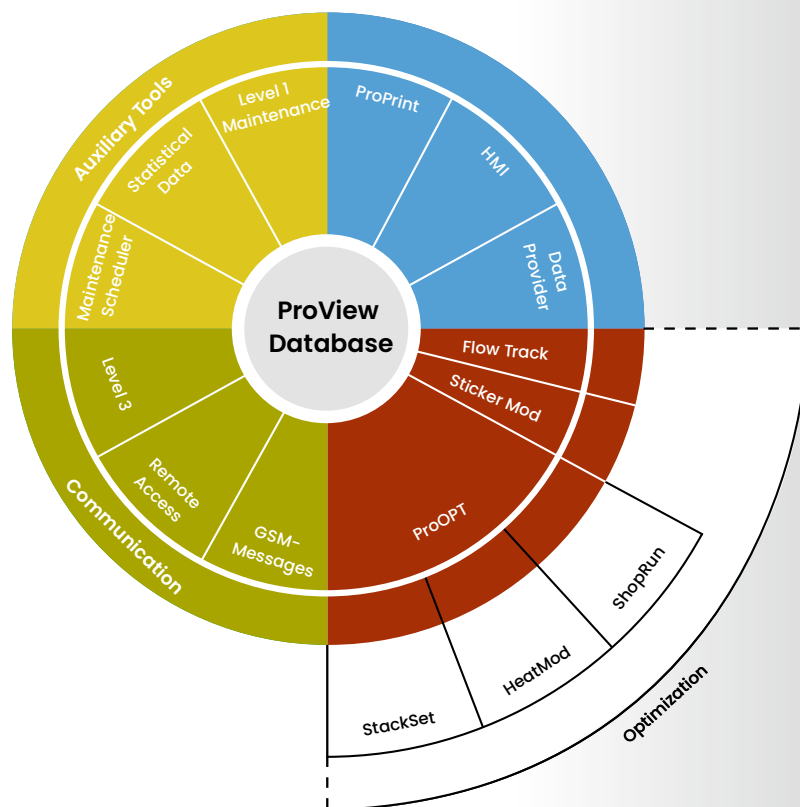

### FUNCTIONS AND OPERATION

- Graphic overview of plant status with colour coding to indicate the current status of each individual base
- Presentation in variable windows to allow viewing of annealing curves for different bases at the same time
- Zoomable presentation of graphics windows (e.g. curves, base overviews, P-I diagrams)
- Presentation and storage of process-relevant data (coil data, detailed presentation of selected annealing and gas purging programs)
- Process visualization for individual bases, showing mechanical details, media present and flowing, status of motors and valves
- Rapid curve recording for analysis purposes, covering an adjustable number of annealing cycles per base; this function is dependent on the control system used
- Graphic module for curve presentation and visualization of all relevant process values with zoom function for curves (temperatures, flows, fan speed, pressures, oxygen concentrations and vibration values)
- Flexible, adjustable presentation of diagrams for individual process stages
- Curve overlay function for the comparison of annealing cycles
- Possibility of direct input of annealing program setpoints or transfer from an internal ProView®.NET program library or from a higher-level production computer
- Setpoint record library with editing function
- Long-term archiving of annealing data using internal ProArchive software
- Flexible backup configurations for annealing data



- Annealing log printouts (on paper and as pdf files) and hard copy function for all screenshots
- Alarm processing with error classes
- Communication with base control units via Ethernet (TCP/IP)
- Integration of customer software possible

### SAFETY

- Siemens failsafe technology
- Safety-First safety package with comprehensive check lists and plausibility checks
- Presentation of current malfunctions and archiving in logbook
- Rational database for process data archiving (e.g. Oracle)

- Extended user administration with flexible assignment of access rights

### EFFECTIVENESS

- Management of vacant or occupied heating and cooling hoods and bases
- Production monitoring

### OPTIONS

- Statistical process control for coil data, temperatures, gas consumptions, performance data, etc.
- Statistical evaluations in accordance with customers' requirements

- Service support for system maintenance by customers' personnel with remote maintenance access from the Tenova LOI service centre
- Connection to control computer for automated data interchange
- As software is developed in-house, customer-specific modifications to the system can be carried out at any time

▼ Control system configuration for a Bell-type Annealing Plant

## CONTROL PHILOSOPHY PROVIEW®.NET

Base Control with S7-1500 incl. Remote I/O and ProView®.NET

### Base Controller with S7-1500 incl. Remote I/O and ProView

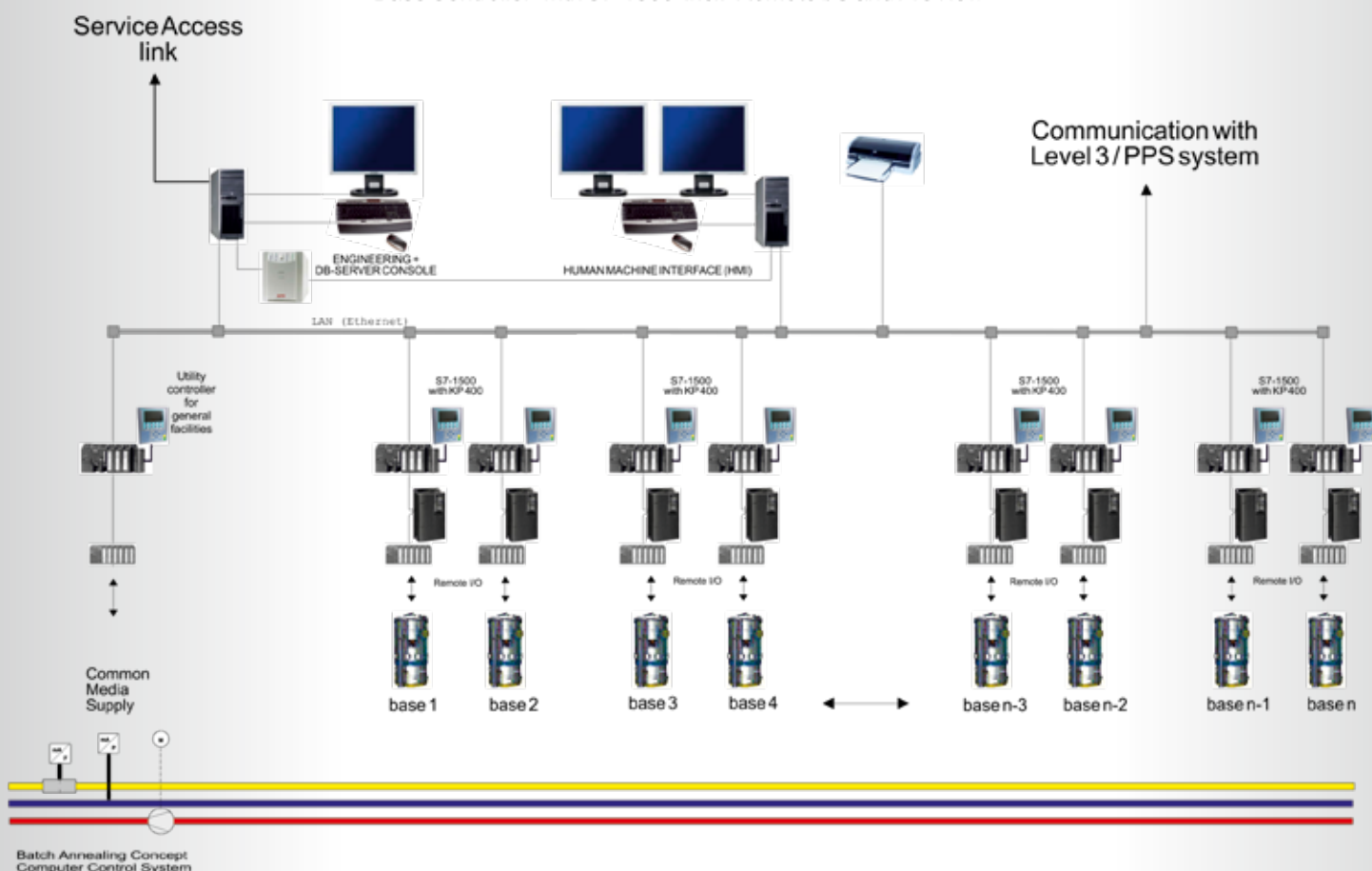

# Software Modules for Production and Capacity Optimization

## ProOpt® – optimized operations management

ProOpt® automatically plans the deployment of equipment and material to be annealed in such a way as to maximize the output of the annealing shop. The equipment covered by the program includes bases, inner covers, convecter plates, heating and cooling hoods, final cooling stations, cranes, hoists and trucks. The material includes the individual coils in stock or arriving at the annealing shop during the planning period considered.

On the basis of the data available, ProOpt® prepares an operating program with full information on the sequence of operations.

The maximum possible production output is determined on the basis of this program, the current plant status and the material in stock.

ProOpt® consists of the following modules:

- StackSet: optimized stack assembly
- HeatMod: heating and cooling model
- ShopRun: equipment and material scheduling

The software modules may be used either independently or as combinations of several modules.

### StackSet

The StackSet module assembles optimized stacks for the annealing process on the basis of coil data such as material grades, weights, dimensions, load limits and surfaces.

The main criteria for optimized stacks are:

- Maximum stack heights and charge weights

- If applicable, heating time estimates, coil positions and cooling under heating hood
- Compliance with delivery specifications
- Compliance with production priorities

Using StackSet, a number of customers have been able to achieve significant performance improvements at their Bell-type Annealing Plants.

### HeatMod

HeatMod is a thermodynamic model for calculating heating and cooling processes for coil stacks in a Bell-type Annealing Furnace. The program allows highly precise predictions with an accuracy of  $\pm 3$  K. Compared to conventional annealing time determination using tables or empirical formulae, HeatMod allows significant time and energy savings or performance improvements at the

## THE OPTIMIZATION MODULES DEVELOPED BY TENOVA LOI

### ProOpt® StackSet, HeatMod, ShopRun

### FlowTrac

### StickerMod

ensure easier, more effective planning and operation and higher plant efficiency. These modules are unparalleled in their functions and their range of parameters. E.g. the HeatMod optimization tool is based on a mathematical model and allows the calculation by differential method of as many temperature graphs as may be required.

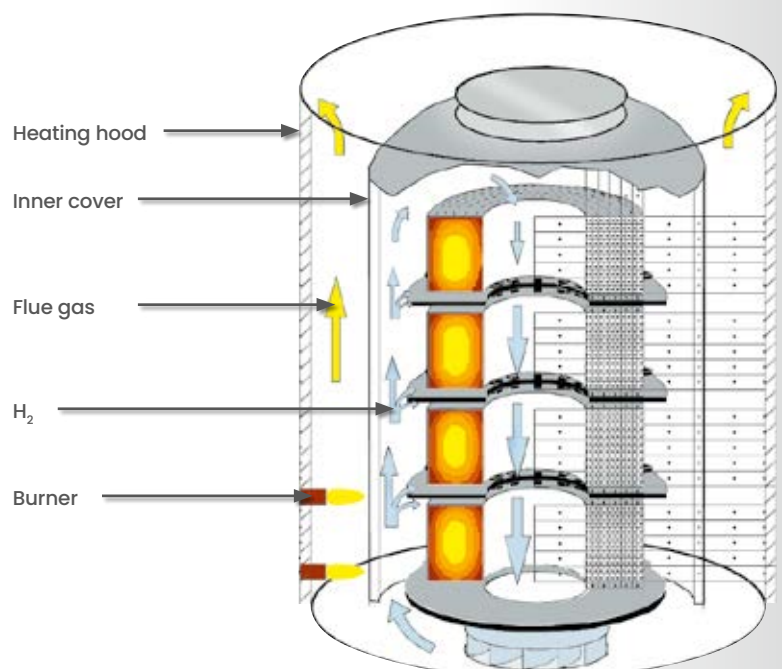

HeatMod – mathematical model ►  
for calculating coil temperatures  
by differential method



same time as maintaining or even improving product quality. The soaking time may be calculated either on the basis of the core temperature or equivalent time or the core temperature plot during cooling under the heating hood. An additional coil position option offers further optimization possibilities. Another advantage is the possibility of developing new annealing processes without complex tests requiring thermocouples.

The HeatMod program has two modes of operation:

- Off-line: for calculating the probable annealing time and annealing temperature for coil stacks
- On-line: for monitoring temperature set points and initiating alarms if the temperature is outside a set tolerance band

#### **ShopRun**

ShopRun plans the deployment of equipment and material to be annealed. This model represents the link between StackSet, HeatMod and the other control components.

Using a special algorithm, ShopRun calculates the combination of plant components and materials which will ensure the most efficient operation of the plant. This combination is shown in the form of a table and a graphic display.

#### **FlowTrac – automatic material tracking**

FlowTrac automatically tracks all movements of equipment and materials.

#### **StickerMod – the mathematical model for reducing stickers**

StickerMod is a mathematical model based on HeatMod which calculates mechanical stress inside a coil on the basis of a wide range of factors and compares them with the maximum stress which can

be allowed if stickers are to be avoided. If the calculated stress exceeds the critical values, the annealing conditions concerned are automatically adapted.

#### **Mobile solutions**

A wide range of mobile solutions are available for process supervision, process control and maintenance purposes.

The visualization can be adapted to various commercially or industrial available mobile devices. Depending on the configuration, process information such as current temperatures, volumeflows and setpoints as well as annealing status and fault-messages can be observed, acknowledged and/or changed via wireless network. Furthermore, by utilizing the sophisticated maintenance package the personnel at site is empowered to retrieve additional information and troubleshooting guidelines for specific instruments by scanning QR-codes directly attached to the equipment or menu-driven by touchscreen.

# Multi-Stack Bell-type Annealing Furnaces for the High-temperature Annealing of Grain-oriented Electrical Sheet (MBAF)

In the production of grain-oriented electrical strip, the material is annealed at about 1,200 °C following decarburizing and coating to obtain defined grain growth and a specified surface layer on the electrical strip.

In contrast to their widespread use for carbon steel and stainless steel, single-stack bell-type annealing furnaces have not become an

established solution for the annealing of grain-oriented electrical steel sheet. Most of the new plants constructed for these applications over the past 20 years have therefore been Multi-stack Bell-type Annealing Furnaces (MBAF). Tenova LOI has been the world's leading supplier of this type of plant for more than 50 years. Several hundred bases are in operation throughout the world.

As with HPH® plants, a 100 % hydrogen atmosphere is used. The process and safety technology of HPH® plants is therefore also applied to MBAF plants.

The charge is cooled by a cooling system integrated in the heating hood; depending on the individual process, a separate cooling hood may also be used in the lower temperature range.

- As a result of the high annealing temperatures (1,170 to 1,220 °C), heat transfer is mainly by radiation and annealing bases are not equipped with recirculation fans.
- Sand trough seals between the inner cover and the annealing base are preferred.
- During the annealing cycle, the atmosphere gas composition is changed several times for process engineering reasons.
- During the annealing process, the heating chamber under the multi-stack heating hood is filled with the same protective atmosphere as the inner cover.
- Throughout the world, it has become normal practice to install electrically heated MBAF plants. Multi-stack plants for two-layer operation have already been constructed with gas firing systems: in this case, special safety systems are required.



- ◀ Normally, three or four individual charge stations are installed in a row under the heating hood.
- ▼ Smaller coils ( $\leq 12$  t) are often charged in two layers. In other words, two coils may be stacked on each other on self-supporting plates. Two-layer charging is usually not used for larger coils ( $> 12$  t), which are therefore charged in one layer on a charge plate manufactured from a high-temperature resistant alloy or positioned directly on sand on the base.



## Other Types of HPH® Plants for Wire and Non-ferrous Metals

Tenova LOI Thermprocess Bell-type Annealing Plants for wire and non-ferrous metals are equipped with HPH® (High Performance Hydrogen) technology. They can be operated either with a controlled atmosphere of nitrogen, HNx or pure hydrogen.

The high heat transfer rate possible with hydrogen also contributes to excellent annealing results with minimal annealing times.

Annealed wire of the highest quality can only be produced with an extremely clean, controlled atmosphere. At Tenova LOI Thermprocess the base plate of the annealing base is designed to provide a fully gas-tight seal between the annealing space and the surrounding air. Controlled atmosphere dew points of  $-60\text{ }^{\circ}\text{C}$  and better can be reached.

### Bell-type Annealing Plants for wire

- Tenova LOI market share over the past 10 years: 50 %
- Both multi-stack and single-stack plants available
- Multi-stack plants with recirculation up to material temperature of  $900\text{ }^{\circ}\text{C}$
- High-performance atmosphere gas recirculation system
- Hydrogen or nitrogen atmosphere
- Sturdy cast diffusor system
- Dew points below  $-60\text{ }^{\circ}\text{C}$
- Annealing without decarburization
- Useful diameter up to 4,600 mm
- Stack height up to 5,400 mm

### Bell-type Annealing Plants for non-ferrous metals

- First reference from 1949
- Both single-stack and multi-stack plants available for wire and sheet
- High-performance atmosphere gas recirculation system
- Hydrogen, nitrogen or other atmosphere gases possible
- Advanced vacuum technology for evacuation
- Very high process quality; dew points below  $-60\text{ }^{\circ}\text{C}$
- Sophisticated plant design and process technology for high plant productivity and material quality
- Useful diameter 800 to 2,400 mm

▼ HPH® Multi-stack Bell-type Annealing Plant for wire

▼ HPH® Bell-type Annealing Plant plant for bright annealing CuZn coils



# SERVICE AND SPARE PARTS

Our dedicated service system makes the full know-how of Tenova LOI Thermprocess, which has been gathered over the decades and is still being developed, available to our customers at all times. The worldwide representation of Tenova means that our customers have direct access to our specialists for spare parts and services, as well as modernization, retrofit and relocation projects, all tailored to their specific needs.



## COMPLETE SYSTEM SOLUTIONS INCLUDING AUXILIARY EQUIPMENT

On request, Tenova LOI Thermprocess is able to supply precisely tailored auxiliary components for optimal operation of the plant and highest

efficiency. Such peripheral components may include:

- Special tongs for handling coils, covers, hoods and convector plates
- Final cooling stations (equipped with air drying systems, if required)
- Water cooling systems
- Hydrogen production systems
- Hydrogen treatment systems
- Fuel gas treatment systems (e.g. for coke oven gas)
- Coil tilting systems
- Internal spot welding machines

## INTERNATIONAL MANUFACTURING

The international networking of design, purchasing and manufacturing is often an effective way of reducing fabrication and transport costs, shortening delivery times and increasing the benefit to the customer. Tenova LOI Thermprocess has decades of experience in the implementation of networked projects of this type. The targeted selection, supervision and control of production facilities in other countries are among the core competences of Tenova LOI Thermprocess. Our cooperation arrangements with a number of fabrication plants in Germany, Europe, America and Asia allow flexible, low-cost project management combined with high quality levels for the benefit of our customers. Our highly qualified international manufacturing supervision team ensures compliance with our high quality standards.

## SERVICES

We provide our customers with tailor-made maintenance programs, regular technological updates, operation assessment and personnel training.

## SPARE PARTS

The right spare parts can be supplied within the shortest time (e.g. 24 h). On request, a web-based catalog for new and old equipment can be created, which facilitates the

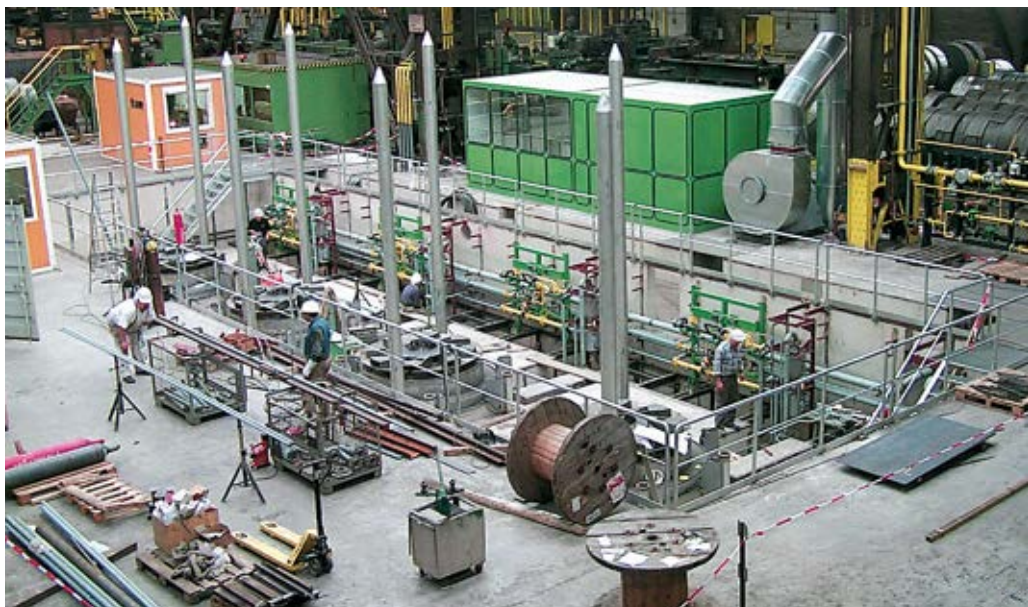

▲ Assembly of an HPH® Bell-Type Annealing plant

identification of spare parts and simplifies procurement considerably.

## MAINTENANCE AND REPAIR

Our experts are available for maintenance work on process control systems including mathematical models and on systems including mechanical and electrical elements, refractory linings, burners, heating/cooling systems, controllers and automation devices.

## MODEM AND TELEPHONE SERVICE

Control systems and connected plants can also be inspected online by remote diagnosis.

## RETROFIT AND MODERNIZATION

Our specialized service solutions allow customers to operate at the highest possible productivity and efficiency levels at the same time as focusing on safety and sustainable development.

## CONSULTANCY

Our process engineers and our commissioning and control systems specialists are available to provide advice to customers either on-site or via remote diagnosis.



# Sustainable solutions for a green transition of metals

## Tenova LOI Thermprocess Poland

### LOI Poland Sp. z o.o.

ul. Zagórska 79  
Tarnowskie Góry  
42-680 - Poland  
T +48 32 284 1639  
F +48 32 284 2223  
loi@tenova.com

## Tenova LOI Thermprocess India

### Tenova Technologies Pvt Ltd

IThink Techno Campus  
A Wing, 5<sup>th</sup> Floor  
Off Pokhran Road No. 2  
Thane (West)  
Thane, Maharashtra 400601  
India  
T +91 22 6248 9700  
tenova.in@tenova.com

## Tenova LOI Thermprocess Tianjin

### Tenova Technologies (Tianjin) Co., Ltd.

2<sup>nd</sup> Floor - Tower B,  
Keyuan Keji  
Development Centre No. 8,  
Keyuan East Road Tianjin  
Hi-Tech Industry Park  
Tianjin, 300192 - China  
T +86 22 87 890 588  
F +86 22 87 892 018  
loitj@tenova.com

## Tenova LOI Thermprocess United States

### Tenova Inc.

Cherrington Corporate  
Center Corporate Center  
Drive 100  
Corapolis  
PA 15108-3185 - United States  
T +1 412 262 2240  
F +1 412 262 2055  
tenova.usa@tenova.com



[www.tenova.com](http://www.tenova.com)

## Headquarters

Tenova S.p.A.  
Via Gerenzano, 58  
21053 Castellanza, VA  
Italy

TECHINT GROUP

**tenova**  
LOI THERMPROCESS

## LOI Thermprocess GmbH

Schifferstrasse 80  
47059 Duisburg  
Germany  
e-mail: [loi@tenova.com](mailto:loi@tenova.com)

[www.loi.tenova.com](http://www.loi.tenova.com)