

# Aluminium Thermal Processes

For optimized material properties



# TENOVA LOI THERMPROCESS

Tenova LOI Thermprocess is one of the leading companies in supplying industrial furnace systems for the heat treatment of metals. Worldwide clients from the steel, aluminium and automotive industries rely on the technical solution competence and thousands of references backed by a history of over 100 years representing the entire know-how in the field of material properties and secondary metallurgy. Tenova LOI Thermprocess is a global partner represented in all major markets throughout the world.

Being a driver in the transformation of the metals industry towards decarbonization and sustainability, we implement proven process solutions and focus on the development and implementation of fossil-free melting and annealing processes under usage of electrical heating or Hydrogen combustion.

As digitalization is one of the key drivers in our business, all our processes are enhanced by our smart digital solutions. We provide the full range of solutions for the whole life-cycle of the equipment from a single source: from new plants to modernization, maintenance and service.

Tenova LOI Thermprocess offers reliable and green solutions that minimize the environmental impact and guarantee quality, production efficiency and safety. Tenova LOI Thermprocess is a trademark of Tenova.

# Tenova companies for thermal processes and systems for Aluminium:



Melting / casting / recycling plants



Heat treatment plants



Strip processing lines



Energy recovery technologies



Roll grinding equipment



# ALUMINIUM – LIGHTWEIGHT, INNOVATIVE AND COMPLETELY RECYCLABLE

Due to its unique properties and the optimal recyclability of used aluminium components, aluminium is a trend-setting material for automobiles, mechanical engineering and aviation industry and outclasses alternative materials with regard to many future-oriented solutions.

## **Aluminium**

- low density
- favourable corrosion resistance
- high electrical conductivity
- high thermal conductivity
- high stability
- good formability
- excellent light reflection
- numerous possibilities of surface treatment
- unrestricted recycling without loss of quality



# Table of Contents

<b>Aluminium Melting and Casting Furnace Plants</b>	<b>6</b>
Melting furnaces	8
Casting furnaces	9
<b>Aluminium Recycling</b>	<b>10</b>
TCF® technology	11
Twin-chamber melting furnace TCF®	12
<b>Aluminium Heat Treatment</b>	<b>14</b>
al-loi® Process technologies	14
Automotive casting	16
Aviation	19
Automotive forgings	20
Automotive structural components	22
Rolling mill	24
Foil annealing plants	25
Strip annealing plants	26
<b>Automation System</b>	<b>28</b>
<b>Service</b>	<b>30</b>

# ALUMINIUM MELTING AND CASTING FURNACE PLANTS

Aluminium melting and casting furnaces are used to melt block metal and clean scrap and to cast the liquid metal in casting plants. The furnaces are either stationary or tiltable; they can be equipped with special charging machines and be adjusted to individual production conditions.

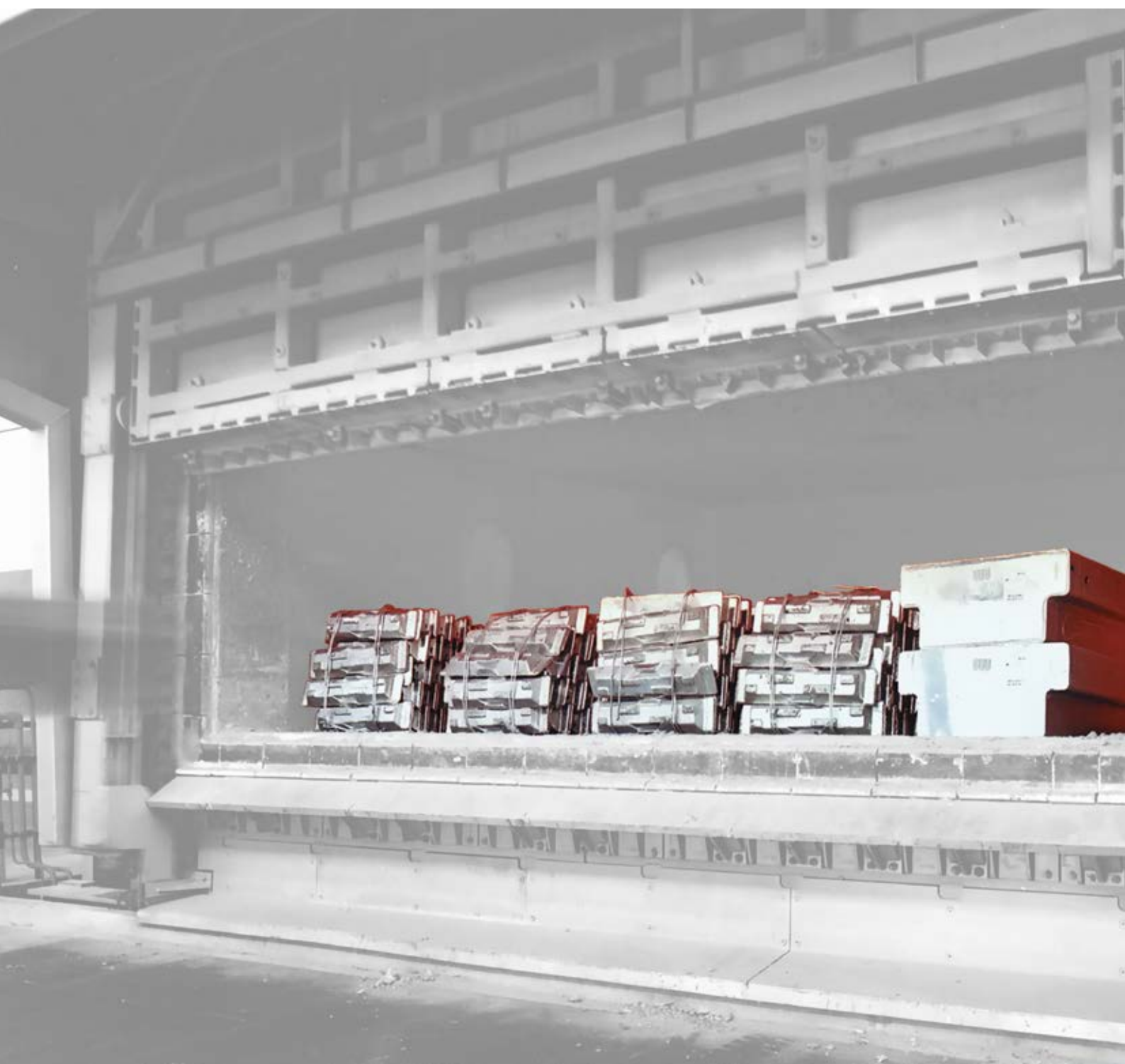

## MELTING AND CASTING PLANTS

The melting and casting furnaces of Tenova LOI Thermprocess can be either tiltable or stationary. They are heated with gas or oil burners. The energy consumption is reduced due to regenerative heat recovery and furnace pressure control. A fully automatic control system ensures the constant quality of the melt; an optimal process control contributes to reduced metal loss. Mathematical modeling supports the process optimization. Dimensioning and design of combustion, metal flow and heating curves are basing on numerical models, for optimum conditions. The Know How from decades of experience in design and process technology leads to highly efficient equipments.

Tenova LOI Thermprocess optimizes the melting and heating process by mathematical models of the furnace plants. The plant design is based on the optimized combustion process, melt movements and heating profiles. The today's optimized furnace plants result from the know-how of design and process technology which was gathered in decades of practical experience.

The **al-loi®** melting and casting plants distinguish themselves with

- high energy density
- uniform heating of melting bath
- metal circulation for melt homogenization
- purging gas treatment in the furnace
- reduced hydrogen absorption
- charging machines for optimized production process
- melting aggregates for chips

The furnaces are heated by open burner flames. The burner arrangement ensures a uniform heating of the furnace chamber and the melt bath. Aiming at reduced energy consumption and metal loss, the individual burner control takes care of uniform and optimal combustion conditions. Burner regenerators (BCR) or a central regenerator (CCR) can be used for the regenerative heat recovery.

The **al-loi®** heating technology offers

- gas heating
- oil heating
- regenerative heat recovery
- central regenerator CCR
- low oxygen furnace atmosphere
- low noxious emission

## ADVANTAGES OF CENTRAL REGENERATOR CCR

- rapid cooling of combustion gas
- high air pre-heating temperature
- compact design
- uniform heat recovery in a wide performance range
- continuously burning flames
- no switch-over between burners
- optimized burner positioning
- optimal pre-conditions for meeting future emission requirements



Waste gas heat recovery by use of ► central regenerator CCR

## MELTING FURNACES

As the melting furnaces are used for melting block metal or clean scrap, they are equipped with a large charging and cleaning door. Special charging machines facilitate the operation and increase the efficiency.

- melting of block metal
- melt treatment in the furnace
- regenerative heating
- metal circulation by use of a stirrer or pump
- charging machines for block metal and scrap
- large furnace doors
- flat inner walls for easy cleaning
- tiltable or stationary
- fully automatic furnace control
- low metal loss

### Lower CO<sub>2</sub> emissions

- high heat recovery
- low energy consumption
- reduced noxious emission

### High availability

- solid and robust design
- reliable components
- know-how gathered in decades of practical experience
- low maintenance required
- easy operation

## PLANT DATA

Final products	rolling ingots extrusion billets pigs
Furnace capacity	35 – 140 t
Heating system	regenerative burners BCR central regenerator CCR
Fuel	natural gas light oil
Metal circulation	pump stirrer
Charging material	electrolysis metal block metal scrap
Melting rate	5 – 25 t/h
Melt treatment	rotary gas injector
Metal temperature	700 – 860 °C

- ▼ Melting furnaces MCF with a bath capacity of 55 t each





## CASTING FURNACES

The casting furnaces are used as holding furnaces to provide the melt for the casting process. The hydraulically tiltable design is typical of these furnaces as it allows to smoothly feed a casting aggregate with the liquid metal

in a controlled manner. The melt is transferred on the same level from the furnace into the casting equipment by means of a hinged launder. The furnaces are equipped with a large cleaning door. The furnaces offer various possibilities of metal cleaning.

## PLANT DATA

Final products	rolling ingots extrusion billets pigs
Furnace capacity	30 – 140 t
Heating system	cold-air burners regenerative burners BCR
Fuel	natural gas light oil
Metal circulation	stirrer
Charging material	liquid metal alloy elements
Melting rate	2 – 5 t/h
Melt treatment	rotary gas injector porous plugs
Metal temperature	680 – 740 °C

## Particularities

- melt treatment
  - with impeller
  - with porous plugs
  - with lances
- cold air or regenerative heating
- large furnace door
- smooth inner walls for easy cleaning
- tiltable
- fully automatic furnace control
- low energy consumption

## High metal quality

- uniform temperature during casting
- low in hydrogen
- precise level control in the launder
- closed oxide skin during casting
- smooth metal flow



- ◀ Casting furnace CF to be fed with liquid aluminium, used for alloy up and for feeding casting plants. Bath capacity of 35 t, heated by natural gas.

# ALUMINIUM RECYCLING

The TCF® process, developed by Tenova LOI Thermprocess is subject to continuous optimization. This process is applied for recycling aluminium scrap (returned from production) and scrap metal with sticking oil, grease, lacquer, plastic or thermal insulation layers (end of life). The combination of a Twin-Chamber Melting Furnace TCF® with a waste gas purification plant is a reasonable solution for aluminium recycling in ecological and economic terms.

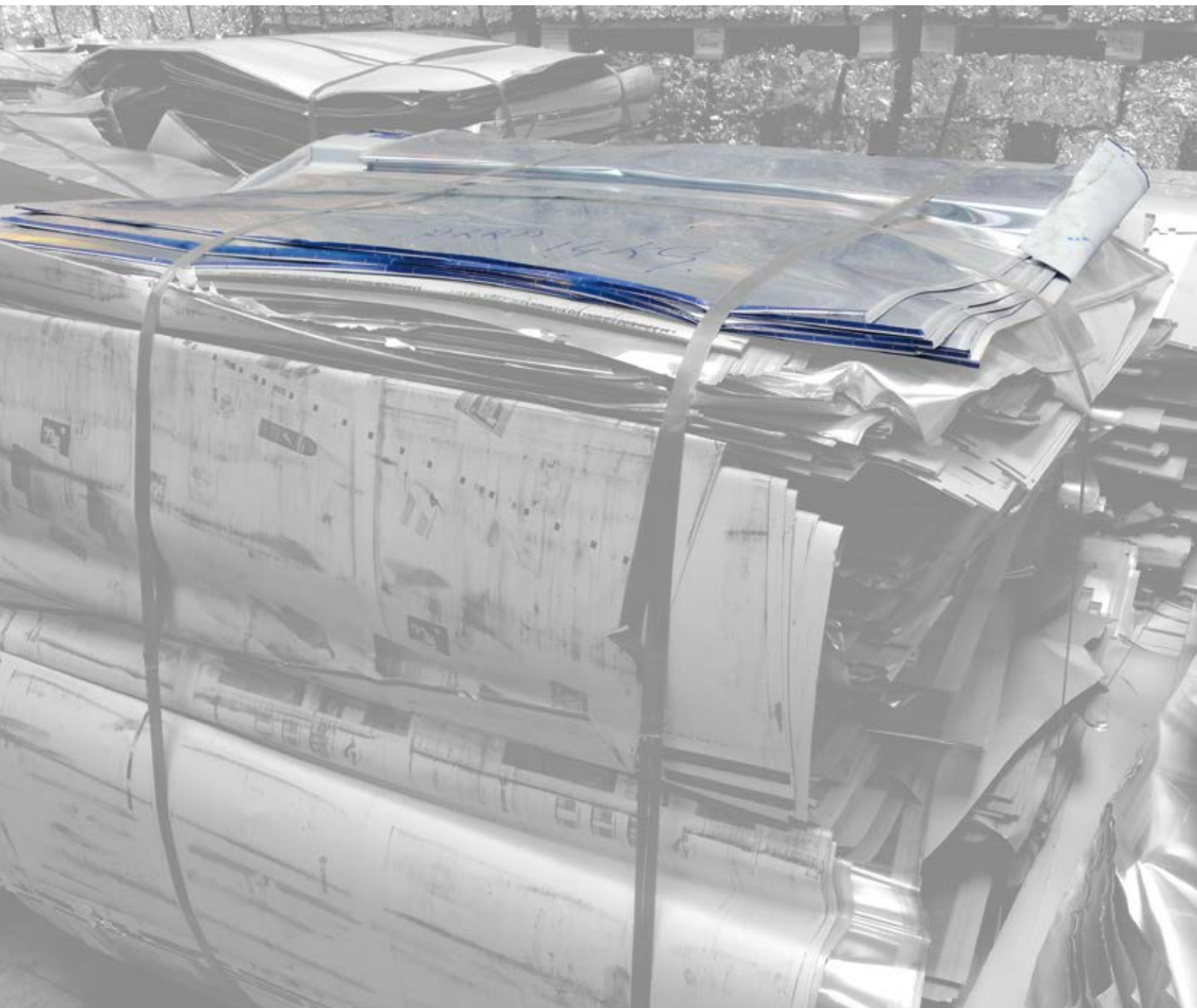

### TCF® TECHNOLOGY

- recycling of scrap with contamination
  - chips
  - thin-walled scrap
  - small-sized scrap
- no scrap pre-treatment is required
- scrap pre-heating in reducing furnace atmosphere
- melting in liquid metal bath
- oxygen-free scrap chamber prevents metal loss
- recycling without using salt
- optimized oxygen control in the heating chamber
- waste gas quenching for emission reduction
- homogenous melting bath due to continuous metal circulation
- low metal loss
- lowest energy consumption

### Favourable Environmental Compatibility

- The pyrolysis gas originating from the adhering substances is led into the reaction zone of the heating chamber.
- Emissions and energy consumption are reduced due to the use of the pyrolysis gas.
- Integrated in the furnace with a long dwell time and high temperatures, the pyrolysis gas is safely and environment-friendly burnt.
- A rapid quenching (2,500 K/sec) of the combustion gas avoids the re-combination of dioxins.

- The waste gas is cleaned of dust and harmful gas components (HCl, HF etc.) in the course of the special waste gas purification process.
- Due to the regenerative heating system including CCR the combustion air pre-heating is increased; the energy consumption is reduced simultaneously.
- The automatic charging machine does not only reduce the flue gas penetrating into the hall, but additionally automates the production process.

▼ Left-hand side: Tilttable Recycling Plant TCF®  
Right-hand side: Recycling Plant TCF®



## TWIN-CHAMBER MELTING FURNACE TCF®

The Twin-Chamber Melting Furnace TCF® comprises a furnace casing with two furnace chambers. While their atmospheres are separated, the two chambers dispose of a common melting bath. First, the scrap is placed and pre-heated on the dry hearth of the scrap chamber; the contaminants are pyrolysed. In the next step, the scrap is pushed into the melting bath for being melted there. The heating chamber accommodates the furnace burners and provides the heat required for the melting process. The recirculating melt flow transfers the melting heat from the heating chamber into the scrap chamber.

### Twin-Chamber Melting Furnace TCF®

- melting of scrap with contaminants
- melting of chips
- melting of scrap without prior pre-treatment
- separated atmospheres in scrap chamber and heating chamber
- scrap pre-heating on the dry hearth
- melting in liquid metal bath
- oxygen-free scrap chamber
- rapid oxygen reduction upon charging process
- oxygen control in the heating chamber
- waste gas quenching by use of the central regenerator CCR
- lowest energy consumption

- fully automatic control system
- safety software for process monitoring

- easy operation
- charging machine with hood
- automatic chip charging

### CHIP CHARGING

The melting aggregate is automatically and continuously fed with chips from a hopper. As the central automatic process control system is responsible for control and monitoring, optimal charging is ensured.

### USE OF BLOCK METAL

Having reached the heating chamber, the block metal is first placed on the dry hearth of the heating chamber for being pre-heated and dried.

- ▼ Twin-Chamber Melting Furnace TCF® for salt-free melting of aluminium scrap with sticking material



### USE OF LIQUID METAL

For the purpose of alloy adjustment liquid metal can be used in the furnace and will be inserted via a liquid metal inlet pocket.

### DISCHARGE OF LIQUID METAL

The melted metal can be discharged from the furnace via tap cones or a pump and will be forwarded to a downstream aggregate (e.g. a casting furnace). While tapping, it is possible to discharge so much liquid metal that the bath is kept filled above the opening in the intermediate wall.

### TYPICAL PLANT DATA

	TCF75	TCF90	TCF120
Final products	rolling ingots – extrusion billets – pigs		
Furnace capacity min.	75 t approx. 40 t	90 t approx. 45 t	120 t approx. 50 t
Heating system	CCR/BCR	CCR	CCR
Air pre-heating	950 °C	950 °C	950 °C
Fuel	natural gas	natural gas	natural gas
Metal circulation	electro-magnetic / mechanical	electromagnetic	electromagnetic
Charging material	contaminated scrap – block metal		
Charge per charging process	2.5 – 3 t	3 – 5 t	4 – 5 t
Chip charging	up to 2 t/h	up to 4 t/h	up to 6 t/h
Production rate	80 t/d	160 t/d	210 t/d
Casting temperature	680 – 760 °C	720 – 760 °C	720 – 780 °C



◀ Twin-Chamber Melting Furnace TCF\* with automatic charging device CM

▼ The CW (Charge-Well) aggregate allows the feeding of chips and small-sized scrap into the metal flow of the bath circulation, which reduces the metal loss due to oxidation.



# ALUMINIUM HEAT TREATMENT

Aluminium is alloyed prior to the casting process in order to achieve specified material properties. Depending on alloy, geometry and the desired features of the structural components, their final characteristics are attained by a component-specific heat treatment program including solution annealing, quenching and ageing.

## al-loi® PROCESS TECHNOLOGIES FOR ALUMINIUM

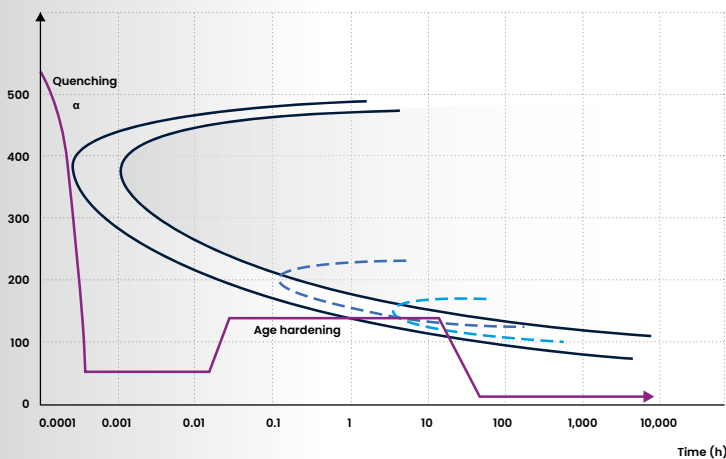

**al-loiH** Heat treatment technologies for aluminium

**al-loiQ** Quenching technologies for aluminium

**al-loiQ W** Water

**al-loiQ P** Polymer

**al-loiQ A** Air

### al-loi® Process development

- physical tests are validated in pre-series
- process development and optimization stipulated in recipes
- supported by mathematical models and
- specified in more details during commissioning and production start-up

Starting with an alloy-dependent process definition, the process development leads to component-specific tests. Mathematical models and the consideration of experiences gathered from commissioning and production start-up contribute to the continuous process optimization.

**al-loi**  
**THERMAL PROCESSES**  
**FOR ALUMINIUM**



## HEATING PROCESSES **al-loiH**

The heating processes for aluminium structural parts include solution annealing and age hardening. During the solution annealing process all alloy components are uniformly dissolved and homogeneously distributed in the material. At the same time the tensions resulting from the casting process are released. This solution state is frozen by quenching.

The strength of the parts is reached during the age hardening process at an increased temperature. The final strength depends on the chosen alloy, the ageing temperature and the ageing time. The ageing process requires an exact and reproducible temperature control as even a minor deviation from the setpoint temperature will have an impact on the material properties.

**al-loiH** offers the heat treatment processes which are indispensable for complying with the most sophisticated requirements. The adherence to the process parameters, which is necessary for achieving optimal material properties, is ensured by the appropriate plants.

The reliable **al-loiH** process allows the pinpoint treatment of the components aiming at low deformation and low residual stress.

## QUENCHING PROCESSES

### **al-loiQ**

A high strength in the structural component is ensured thanks to the homogenous distribution of the alloy components during the solution annealing process. To avoid warping of the structural parts and the resulting significant residual tension,

which might affect the lifetime of the parts, these parts need to be quenched in an extremely homogenous manner. **al-loiQ** provides the required quenching processes including the necessary plant technology.

**al-loiQ A** ensures a rapid and homogenous quenching of the parts by use of air with homogenous and high flow speed.

**al-loiQ P**, using polymer, offers a more abrupt quenching which is applied particularly to components with thicker walls. It ensures low warping and residual tension of the components.

**al-loiQ W**, using water, offers a very abrupt, but uniform quenching. For physical reasons this process, however, entails potentially a higher residual tension.



# ALUMINIUM AUTOMOTIVE CASTINGS

The more the weight will be reduced, the more often components made of aluminium are used for a vehicle. As the parts additionally play an important role with regard to safety technology, their properties have to meet utmost requirements. This is also applicable to components for airplanes.





## AUTOMOTIVE CASTINGS

Castings made of Al-alloys are used in the automotive industry:

- cylinder heads
- engine blocks
- chassis
- trailing and transverse control arms
- cast nodes
- passenger car wheels
- truck wheels

**al-loi®** heat treatment plants distinguish themselves with

- reliable reproducibility of results
- closed material flow
- high flexibility of processes
- little work required for adjustment to particular heat treatment jobs
- adjustability to small lots
- low energy consumption

## FLEX-PLANTS

Meeting the high process and equipment requirements, flex-plants are also suitable to fully automatically treat small lots. Flexible heat treatment lines allow the sophisticated process control promised by **al-loiH**. These plants dispose of a flexible quenching system which is also adequate for the treatment of small lots in **al-loiQ** processes.

## TYPICAL PLANT DATA

	Overhead furnace line OAL	Chamber furnace line BHL
Products		castings forgings
Part size	up to 8,000 mm	up to 4,000 mm
Charge weight	500 – 6,000 kg	500 – 7,000 kg
Heating system	direct or indirect heating with natural gas electrical heating	
Air circulation		vertical horizontal
Quenching media	water polymer air	water polymer air

▼ Artificial ageing plant (overhead furnace line OAL) with air, polymer and water quenching



### CONTINUOUS PLANTS

Continuous plants are used for **al-loiH** and **al-loiQ** in mass production. The structure of such plants allows the arrangement

of a suitable quenching center downstream the solution annealing furnace so that all quenching processes can be flexibly applied. A rapid or step-wise heating can be adjusted in the continuous process. Reversing flow directions ensure the uniform heating-up of complex charges.

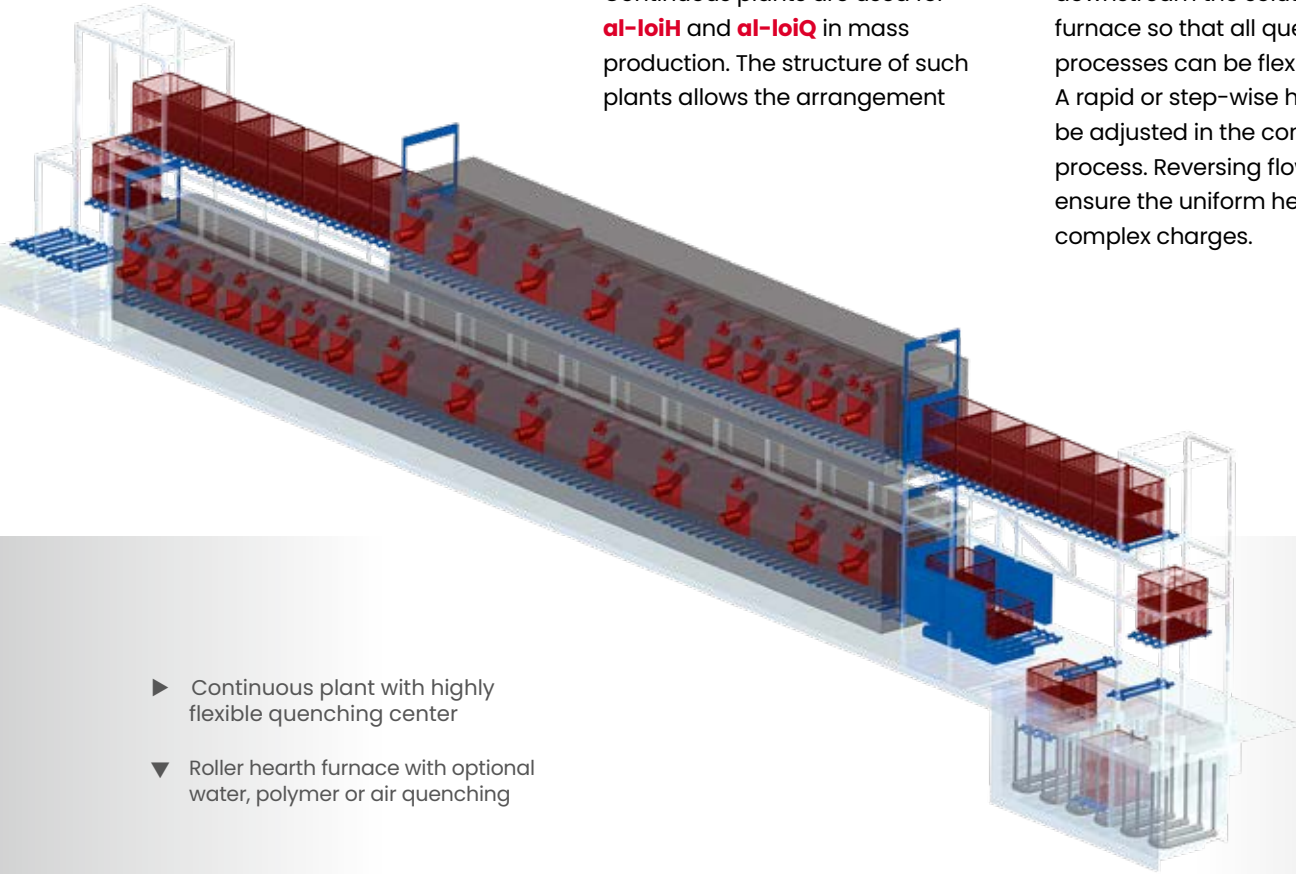

- ▶ Continuous plant with highly flexible quenching center
- ▼ Roller hearth furnace with optional water, polymer or air quenching



## AVIATION



### Aircraft components

The artificial ageing for aircraft components is particularly challenging for the plant engineering and technology. An extremely quick immersion of the sometimes partially filigree components into the quenching medium and a very precise temperature and process control are indispensable for meeting the high quality requirements.

The **al-loi**® heat treatment plants of Tenova LOI Thermprocess fulfill these process conditions.

Quenching delays of less than 7 s and temperature accuracies of  $< \pm 3\text{K}$  are reliably implemented in the **al-loiH** overhead furnace lines in a reproducible manner. These furnace plants are equipped in accordance with the latest AMS standards.

- ▼ Quenching station, optional for air, polymer or water



# ALUMINIUM AUTOMOTIVE – FORGINGS

Aluminium forgings are used for highly stressed applications which require meticulous, individual heat treatment including solution annealing, quenching and age hardening. Tenova LOI Thermprocess offers the right equipment for heat treatment of forged aluminium chassis components and wheels.



## CONTINUOUS FURNACE CCF

Products	forgings
Part size	up to 650 mm
Throughput	4,000 kg/h
Heating system	direct or indirect heating with natural gas electrical heating
Air circulation	vertical horizontal
Quenching media	water

### CONTINUOUS FURNACE PLANTS FOR FORGINGS

The continuous furnace plants with continuous process control offer optimal conditions for large throughputs required for the production of automotive components. The furnace plants may be operated with racks, trays or without any transport auxiliaries.

### CHAIN CONVEYOR FURNACES CCF

Chain conveyor furnaces ensure a precise transport of the parts without racks. As the parts to be

heated are accessible from all sides and considering the smooth transport, this type of furnace plants is suitable for the heat treatment of geometrically complex, sensitive parts.

The charging is executed by a robot which is also used for discharging the heating goods from the solution annealing furnace and its immersion into the quenching bath.

### OVERHEAD FURNACES OAL

In overhead furnaces, forgings are placed in charge racks and optimally quenched due to

the short quenching delay. After the racks have been charged by the operator, they pass the heat treatment process fully automatically.

### CHARGE TRACKING

The automatic charge tracking including documentation of batches and single charging goods is implemented in all furnace plants of Tenova LOI Thermprocess. They can be equipped according to the actual specification AMS2750 or CQI9.

## FURNACE PLANT DESIGNS FOR FORGINGS

### Chain conveyor furnace CCF

- entire integration of the furnace into the fully automatic production line
- parallel charging of several forged parts
- precise and continuous material flow through the heat treatment plant without baskets or grids
- automatic charging and discharging

### Overhead conveyor furnace OCF

- compact plant design; the goods to be heat-treated are arranged in multi-layer racks

- external conveyors, uniform heating and horizontal storage; i.e. low-warping heat treatment
- automatic charging and discharging

### Overhead furnace OAL

- flexible plant conception
- ideal for the heat treatment of small lots
- highly flexible quenching
- fully automatic heat treatment

- ▼ Multi-lane chain conveyor furnace including single-part quenching facility



# ALUMINIUM AUTOMOTIVE STRUCTURAL COMPONENTS

The heat treatment of structural components for the automotive industry typically aims at achieving the state T5, T6 and T7. The precise and stable temperature control and the quenching process are the decisive factors for the quality of the final product.

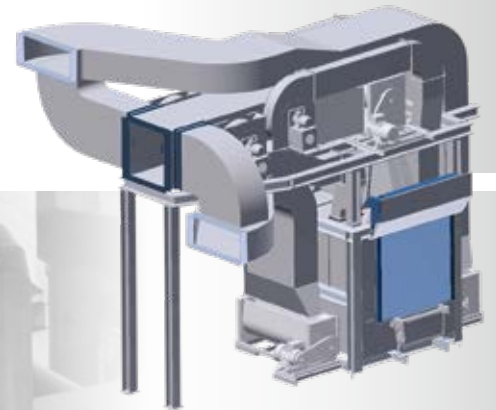

▲ Air quenching chamber for structural components



**al-loiH** and **al-loiQ** are the necessary basis for the plant technology to comply with the requirements of the heat treatment of automotive structural components. The **al-loiQ A** air quench can feature either a form-fitting quenching of parts or a piston flow for the quenching of complete rack piles.

A specific carrier is developed for each structural component. That is inserted into the charge rack and supports the structural part during the complete heat treatment process.

The **al-loiQ A** process with air is actually used for quenching. In future the **al-loiQ P** process with polymer will be a possible alternative for structural components. As result from the ongoing further development of polymer-water-mixtures, the structural parts could be cooled down more rapidly with acceptable warping.

**TYPICAL PLANT DATA**

Continuous furnace RCF	
Products	structural components pressure die casting
Heating system	direct or indirect heating with natural gas electrical heating
Air circulation	nozzle field vertical horizontal
Quenching medium	air
Quenching speed	6 K/s
Furnace temperatures	420 – 520 °C 150 – 250 °C



▲ Air quenching chamber for structural components

**QUENCHING**

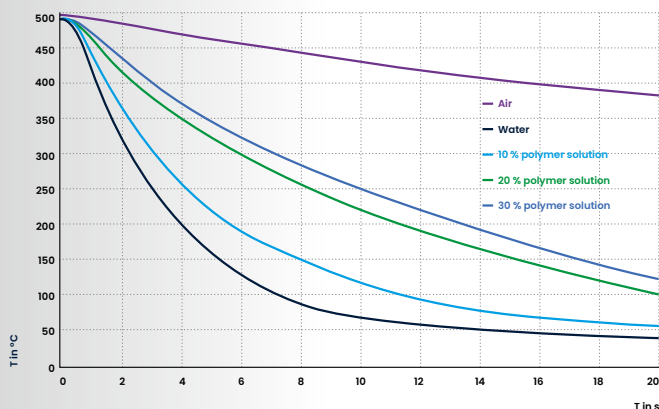

▲ Cooling curves for different quenching media

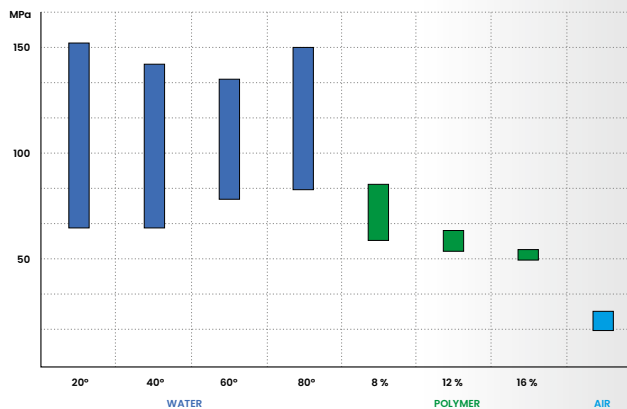

▲ Residual stress after quenching in water, polymer and air

# ALUMINIUM HEAT TREATMENT ROLLING MILL

Strips are annealed after the rolling process to allow further forming. The strain hardening, which results from the rolling process, is reduced by soft annealing. This soft annealing is executed on the strip coil.

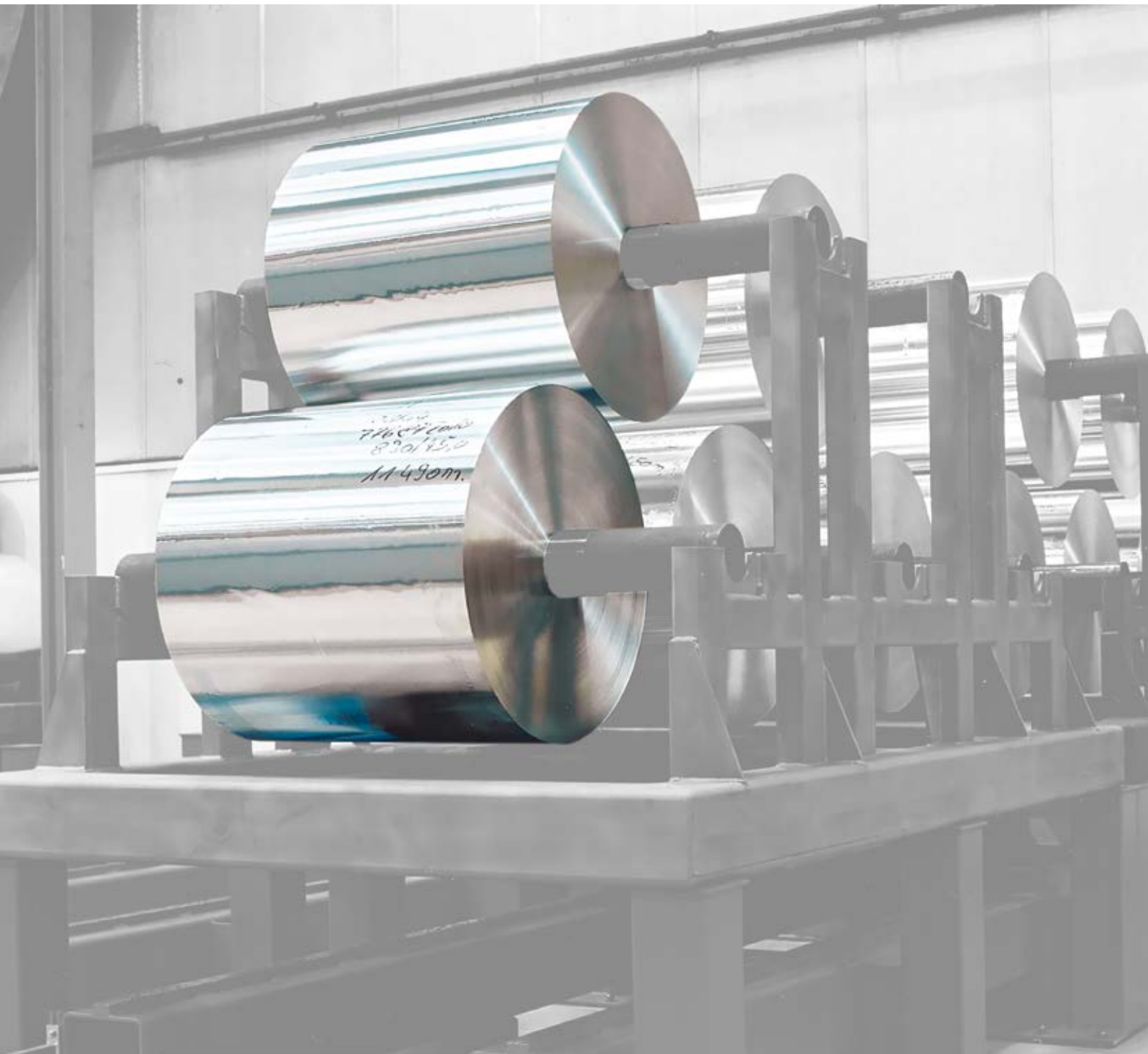



## MULTI-CHAMBER FURNACE PLANT FAL

The foil annealing furnace FAL of Tenova LOI Thermprocess consists of max. 5 separated chambers which can be operated individually. The charges of the foil coils arriving from

the rolling mill are collected on suitable storage places. A set of foil coils is then compiled to a charge and positioned on an annealing rack. The charging is executed by a charging machine which transversely travels to the individual furnace

chambers. All functional processes are executed fully automatically. Every individual heat treatment is assigned to the respective, individual charge, rack or single part, registered and documented.

### TYPICAL PLANT DATA

	Foil annealing furnace plant FAL
Products	foil rolls
Alloy	pure aluminium aluminium alloys
Foil thickness	6 – 200 µm
Coil diameter	1,250 mm
Coil width	1,600 mm
Charge weight	30,000 kg
Heating system	indirect heating with natural gas electrical heating
Air circulation	vertical
Heat recovery	recuperative burners
Temperatures	400 °C
Temperature tolerance	< +/- 3K



▲ Multi-chamber annealing furnace  
▼ for annealing of foil coils FAL.



## COIL ANNEALING FURNACE PLANTS

Strip coils are annealed for the purpose of intermediate annealing during cold rolling, for softening and recrystallization. The annealing can take place under protective gas atmosphere in the furnaces of the Single-Coil Lifting Hearth furnace SCL and Multi-Coil Chamber furnace MCL to prevent the oxidation of the strip surface.

A uniform and rapid heating-up, which aims at heating the strip coil to the desired temperature, is achieved by the impact of jets of the circulated gas on the strip coil.

After the rolling process, oil is removed from the strip surface by annealing. The strip coil is heated up step-wise and held on defined temperatures so that residual oil can evaporate. The resulting steam leaves the furnace during the subsequent purging. It is treated in a thermal post-combustion to make sure that only completely burnt-out waste gas will be released to the environment.

The controlled strip cooling in the furnace – under protective gas atmosphere – is necessary to prevent oxidation. It can be carried out in both furnace lines,

the MCL and the SCL. The furnace atmosphere is directed into a bypass and cooled via a heat exchanger.

## MULTI-COIL CHAMBER FURNACES MCL

Multi-coil chamber furnaces MCL are used in case of large production capacities with homogenous strip coils. Each strip coil is heated in an individually controlled furnace zone. A single or several homogenous strip coils are compiled on a storage place to form the individual charges. A charging machine is used for the automatic furnace charging and discharging.

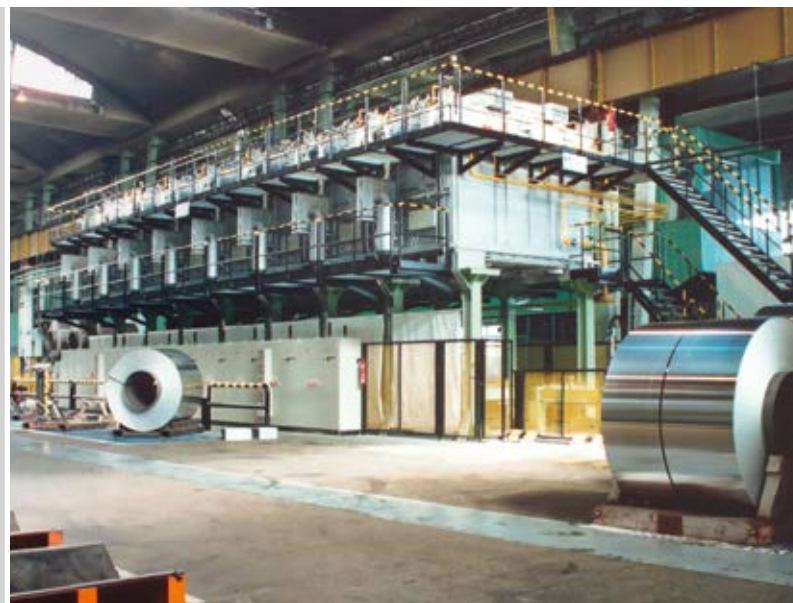
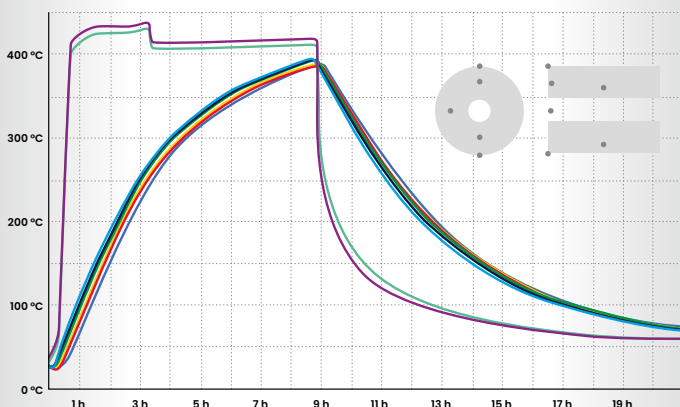

## SINGLE-COIL LIFTING HEARTH FURNACE SCL

The furnaces are elevated on supports and arranged one behind the other in a row. Travelling below the furnaces, the charging machine charges every furnace with a strip coil placed on the furnace hearth. Every furnace is charged with only one strip coil. The respective recipes are stored in the control system. They can be re-called and activated at any time.

HeatMod, the software package Tenova LOI Thermprocess is used for the control of the heat treatment process. Based on the furnace sensor data, the actual state of the strip coil is calculated and the actual process parameters are adjusted accordingly.

The coil annealing furnaces SCL and MCL distinguish themselves with:

- utmost temperature uniformity
  - annealing and cooling process under protective gas
  - post-combustion of furnace atmosphere in a TNV
  - low energy consumption
  - easy handling due to fully automatic charging and discharging
- max. efficiency due to application of the Delta-radiant tube-technology of Tenova LOI Thermprocess
  - minimal process gas costs

Furthermore, the line with Single-Coil Lifting Hearth furnaces SCL offers:

- high flexibility due to quickly adjusted production
- individual annealing of single strip coil
- high efficiency in case of small lots
- connection of furnace plant to fully automatic high-rack and flat storage facilities

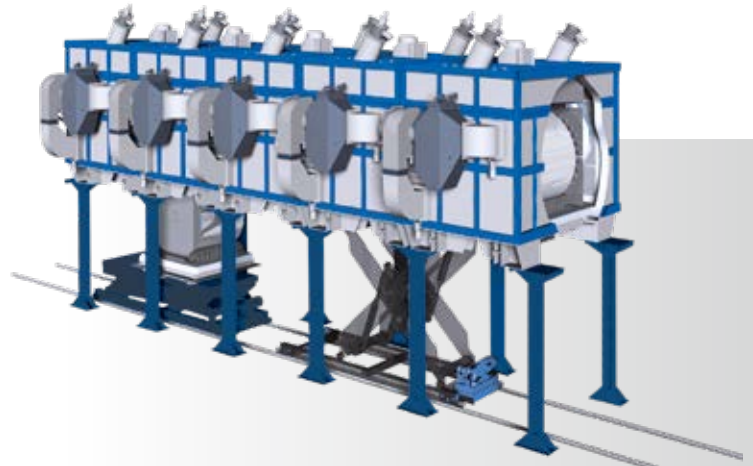
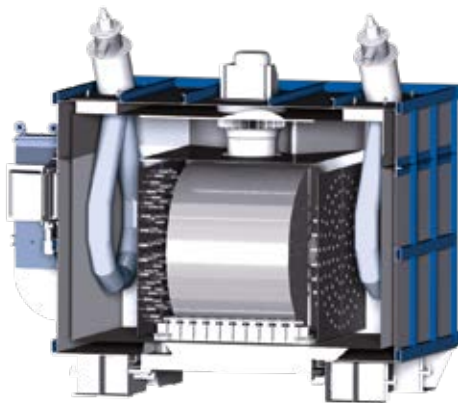

# ALUMINIUM AUTOMATION – SERVICE

Fully automatic processes are indispensable for achieving a high and consistent process quality as well as a reliable and economic series production.

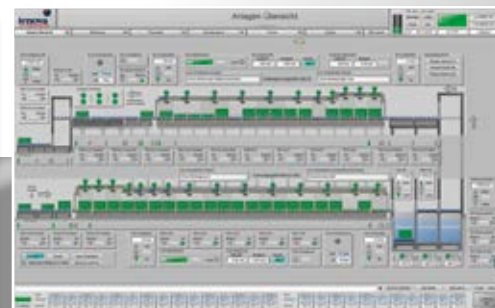

## AUTOMATION

The automation system in the furnace plants of Tenova LOI Thermprocess comprises charge composition, charging process, charge tracking, charge protocols and the furnace control. The operators are continuously provided with clearly arranged and actual information about the process progress and state of the plant components.

A consistent top process quality is thus ensured which in turn is necessary to meet the expectations and requirements of the final customers with regard to the quality of the heat treated parts.

Taking care of the process and furnace plant control, the automatic control system provides the following:

- mathematical models of the processes for the furnace plant control
- recipe administration
- optimized furnace plant operation
- automation systems according to CQ19 HTSA and AMS2750
- result reproducibility
- process optimization

DMC (Data Management Computer)

- job planning
- job history
- recipe administration
- certified reports
- Level 3 data interface

The automatic data recording concerns the

- administration and analysis of sensors/actuators
- process analysis
- trend analysis
- signal monitoring and alarm activation

## PLANT ANALYSIS

The fully automatic furnace plant control does not only consist of the process control, but additionally of the automatic analysis of the plant components and indications for preventive maintenance work. The information is made available to the operator and the maintenance personnel by use of state-of-the-art sensor technology.

Supporting preventive maintenance work, the trends and the behaviour of all components are monitored and analyzed. Intelligent algorithms analyze the incoming data, determine required actions and inform the operators and maintenance personnel accordingly.

The automatic intelligent data analysis for preventive maintenance work allows:

- anticipatory provision of spare parts
- reduction of costs and shutdown times
- optimization of maintenance works
- optimized consumption and analysis
- maintenance assistance system
- proposal of preventive maintenance works
- protocols issued regarding maintenance works

## REMOTE DIAGNOSIS

Thanks to the remote diagnosis our specialists are available within short to support you throughout the world. Using standardized software modules, every of our experts is able to analyse the control system and intervene to give assistance.

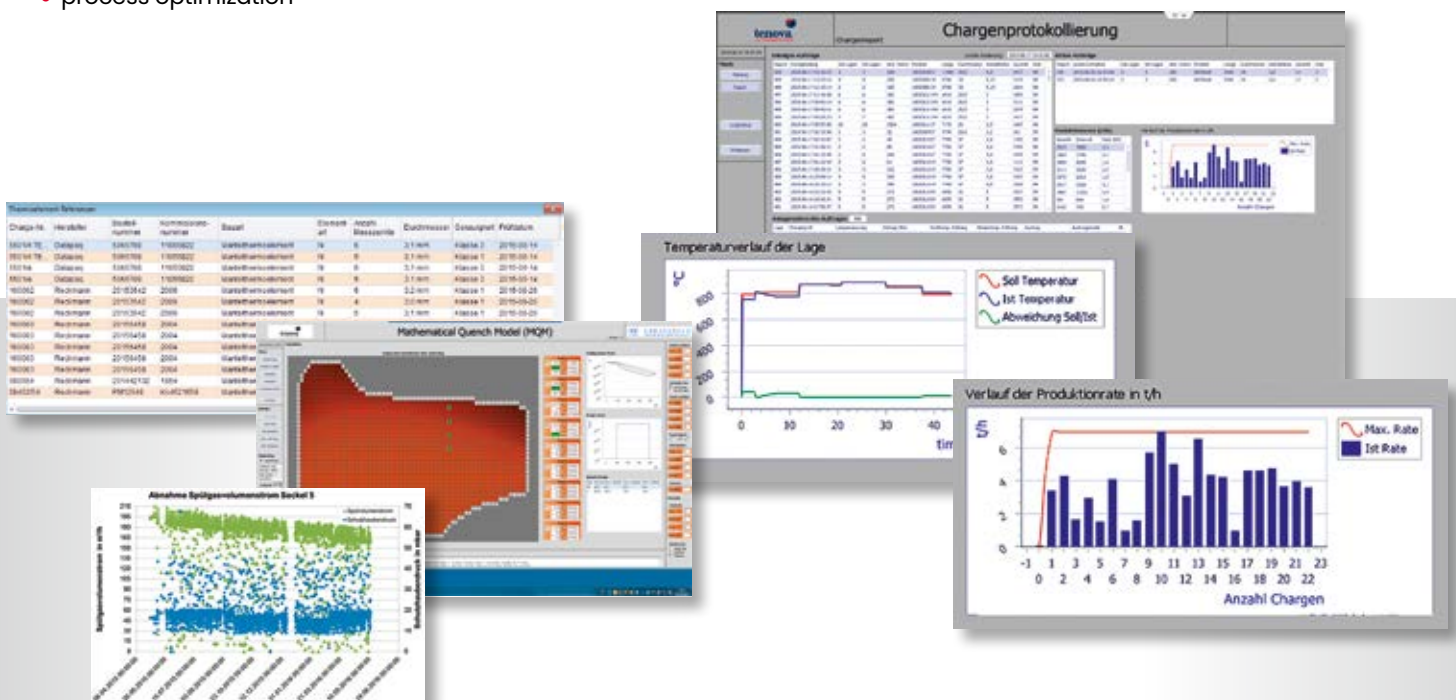

# ALUMINIUM SERVICE

Thanks to our service the continuously growing know-how of Tenova LOI Thermprocess, which has been gathered for decades, is completely available to our customers at all times. The worldwide representation of Tenova grants our customers a direct access to our specialists for maintenance and modernisation.



## DEVELOPMENT OF NEW PROCESSES RESP. OPTIMIZATION OF CURRENT PROCESSES

The services of LOI Thermprocess offer support in the development of new processes and in the optimization of current processes.

A small-series production plant, which can automatically heat-treat components under normal

production conditions, is at our disposal for the creation and development of new recipes and processes. This plant comprises a solution annealing furnace, a quenching centre and an age hardening furnace. The automatic control and the use of charge carriers with real dimensions offer a production-compliant automatic operation including charge tracking and protocols.

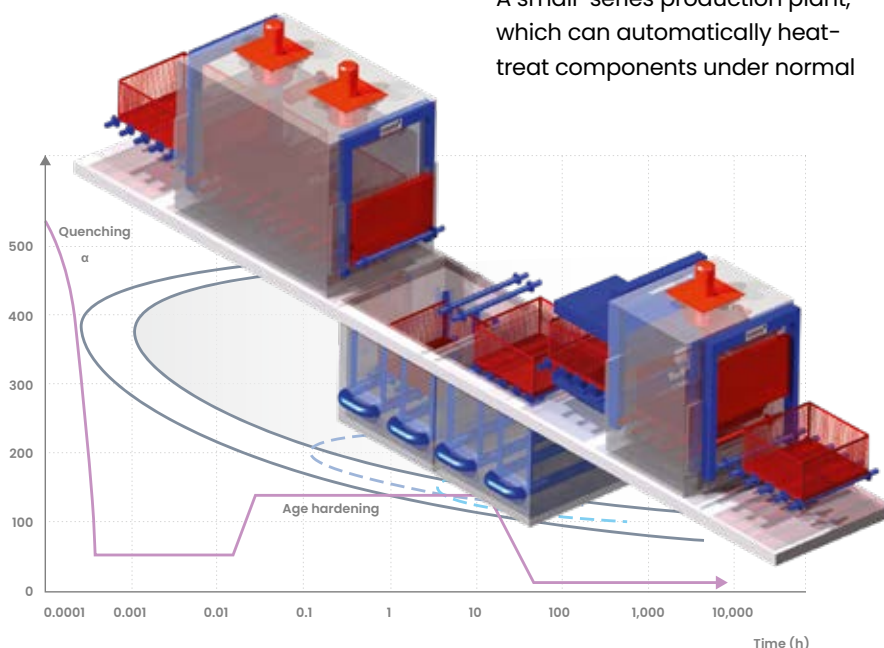

▲ Small-series production plant for the development of new recipes and processes

***service-loi@tenova.com***

*100 % accessibility*

*100 % cost reliability*

*100 % planning security*

***0 % additional cost***

## SERVICE

Our service comprises the remote diagnosis by a specialist of Tenova LOI Thermprocess, a specialist's work on site at the plant and the repair, optimization and extension of furnace plants to adjust them to new process requirements or production capacities.

Thanks to regular software updates, the automation system always disposes of the latest developments and information. This is applicable to the analysis algorithms and the process documentation.

The involvement of specialists of Tenova LOI Thermprocess always ensures a fast and targeted execution and the continuous modernisation of plant components and software. We keep you informed about the latest technical developments and additionally keep your furnace plants updated to state-of-the-art technologies.

The services rendered by Tenova LOI Thermprocess offer:

- reliable furnace plant operation
- high availability
- fast reactions
- minimization of shutdown times
- consultation and training

Classical topics regarding furnace plant modernization are:

- increase of productivity
- increase of efficiency
- increase of operational safety
- software updates
- relocation service
- integration of other plants

Tenova LOI Thermprocess offers the external data storage, issue of charge protocols, continuous remote supervision of the furnace plant and analysis of sensor data during ongoing operation.

Our service activities can be combined to individual packages.

## INDUSTRY 4.0



### Tenova LOI Thermprocess 4.0 offers:

- production data exchange with superordinate ERP / MES systems
- production data recording and analysis at any time... during and after the process
- process and throughput optimization
- alarm management via App / e-mail / SMS
- mobile input of production or measuring data

### Integrable Certification System

The automated evaluation of SAT and TUS is part of the integrable certification system.

- Data input on the spot via a mobile Touch Panel
- Import of TUS-measuring data and their evaluation
- Permanent storage of measuring data
- Memory management for the next tests

As the Mobile Alarm-Management MAM can be implemented on various platforms, the alarms are available everywhere and at all times. As a consequence reaction times can be shortened.



# Sustainable solutions for a green transition of metals

## Tenova LOI Thermprocess Poland

**LOI Poland Sp. z o.o.**  
ul. Zagórska 79  
Tarnowskie Góry  
42-680 - Poland  
T +48 32 284 1639  
F +48 32 284 2223  
loi@tenova.com

## Tenova LOI Thermprocess India

**Tenova India Pvt. Ltd.**  
A Wing, 5<sup>th</sup> Floor  
iThink Techno Campus  
Pokhran Road No. 2  
Thane (West)  
Thane, Maharashtra 400601  
India  
T +91 22 6248 9700  
tenova.in@tenova.com

## Tenova LOI Thermprocess Tianjin

**Tenova Technologies  
(Tianjin) Co., Ltd.**  
2<sup>nd</sup> Floor - Tower B,  
Keyuan Keji  
Development Centre No. 8,  
Keyuan East Road Tianjin  
Hi-Tech Industry Park  
Tianjin, 300192 - China  
T +86 22 87 890 588  
F +86 22 87 892 018  
loitj@tenova.com

## Tenova LOI Thermprocess United States

**Tenova Inc.**  
Cherrington Corporate  
Center Corporate Center  
Drive 100  
Coraopolis  
PA 15108-3185 - United States  
T +1 412 262 2240  
F +1 412 262 2055  
tenova.usa@tenova.com



[www.tenova.com](http://www.tenova.com)

## Headquarters

Tenova S.p.A.  
Via Gerenzano, 58  
21053 Castellanza, VA  
Italy

TECHINT GROUP

**tenova**   
**LOI THERMPROCESS**

## LOI Thermprocess GmbH

Schifferstrasse 80  
47059 Duisburg  
Germany  
e-mail: [loi@tenova.com](mailto:loi@tenova.com)

[www.loi.tenova.com](http://www.loi.tenova.com)